

**Test Report 8365614.**  
Smart Systems Limited  
Incorporating Smart Extrusions

## Introduction.

This report has been prepared by Adam Pearce and relates to the activity detailed below:

Job/Registration Details	Client Details
<b>Job number:</b> 8365614 Job type: Testing Samples Submitted Start Date: 05/09/2016 Test type: Type Sample ID: 10156882 <b>Registration:</b> KM 530838 Scheme: BS 4873 / PAS24 Protocol: PP519 Scheme Mgr: Lorraine Balch Quality system: ISO 9001:2008	Smart Systems Limited Incorporating Smart Extrusions Arnolds Way Yatton BS49 4QN United Kingdom

The report has been approved for issue by Mark Manito – Team Manager

Approved For Issue	
	Issue Date: 17 March 2017

## Objectives.

Type test for product certification.

## Product Scope.

Visofold 1000 Aluminium Bi-fold Doors

## Report Summary.

The samples were received on 31 August 2016 and the testing was started on 7 September 2016.

The samples submitted complied with the requirements of the test work conducted.

## Description of Test Sample.

<b>Outer Frame width</b>	2700 & 3740	<b>Outer Frame Material</b>	Aluminium
<b>Outer Frame height</b>	2570	<b>Outer Frame Gasket</b>	
<b>Outer Frame Part Numbers</b>		Gasket Type	Epdm
Top	DV14	Manufacturer	
Bottom	DV14	Product Name	
Lock Side	DV14	Product Code	ACDV272, 244
Hinge Side	DV14	<b>Threshold</b>	
<b>Outer Frame section dimensions</b>		Manufacturer	Smart
Width	51.5	Product name	
Depth	70	Product Code	DV14, 171, 271
<b>Reinforcing:</b>	<b>N/A</b>	Materials	Aluminium
Manufacturer		<b>Outer Frame Joint Method</b>	
Product Name		Head	Corner Cleat
Product code		Foot	Corner Cleat /Screwport
Material			

<b>Leaf</b>		<b>Leaf Material:</b>	
Leaf Width:	1200	<b>Leaf Gasket</b>	
Leaf Height:	2510	Gasket type:	Epdm
Leaf Part Numbers:		Manufacturer:	
Top:	DV23	Product Name:	
Bottom:	DV23	Product Code	ACDV272
Lock side:	DV23	<b>Leaf Midrail:</b>	<b>N/A</b>
Hinge Side	DV23	Manufacturer:	
<b>Leaf section size</b>		Product name:	
Width:	60.5	Product code:	
Depth:	74.5	Material:	
<b>Reinforcing</b>	<b>N/A</b>	<b>Leaf joint method</b>	
Manufacturer:		Head:	Corner Cleat
Product Name:		Foot:	Corner Cleat
Product Code:			
Material:			
<b>Bead</b>			
Manufacturer:	Smart		
Product Name:			
Product Code:	DV67		
Material:	Aluminium		
Bead Size:	22 x 17		

## Description of Test Sample.(continued)

Glazing Unit		Glazing Gasket	
Manufacturer:		Gasket Type:	Epdm
Inner Thickness:	6	Manufacturer:	
Spacer Material:	16	Product Name:	
Outer Thickness:	6	Product Code	ACVDV31 ACVG34
Unit Sizes:		<b>Glazing Clip</b>	N/A
<b>Glazing Tape Details</b>	N/A	Manufacturer:	
Manufacturer:		Product Name:	
Product Name:		Product Code	
Product Code			

Hardware			Fixings	Quantity
Hinges:	ACDV331		<i>Refer to Fabrication Manual</i>	
Hinge Protectors:	N/A			
Lock:	ACDV722/723		“ “	
Cylinder:	ACDV258	(with handle ACDV480)	“ “	
Security Cylinder:	ACCCY50/50S3	(with handle ACDV251)	“ “	
Handle:	ACDV251, 480		“ “	
Cylinder Support:	N/A			
Cylinder Escutcheon:	N/A			
Keeps:	Full height	Included in lock kits above	“ “	
Drip Bar	N/A			
Additional Hardware				
Top Guide	ACDV333/381		“ “	
Roller	ACDV332/380		“ “	
Run-up block	ACDV080			
Anti-lift block	ACDV081			

## PAS24:2012 Type Test.

### Product Description (Security Testing)

1 off three leaf glaze in open out hinged bi-fold door assembly with one master leaf and two folding sliding leaves, full glass infill and standard threshold

Note: An additional cylinder test was conducted, see sample description for details.

(Sample ID No 10156882)

Date samples received: 31 August 2016

### Test Results.

- |   |   |
|---|---|
| 1. Manipulation                                   | Test sample met the requirements of the Specification in respect of B.4.3     |
| 2. Infill removal                                 | Test sample met the requirements of the Specification in respect of B.4.4     |
| 3. Mechanical loading                             | Test sample met the requirements of the Specification in respect of B.4.5     |
| 4. Manual check test                              | Test sample met the requirements of the Specification in respect of B.4.6     |
| 5. Soft body impact                               | Test sample met the requirements of the Specification in respect of B.4.8     |
| 6. Hard body impact                               | Test sample met the requirements of the Specification in respect of B.4.9.2.2 |
| 7. Security hardware and cylinder test            | Test sample met the requirements of the Specification in respect of Annex A   |
| 8. Additional hardware Security and cylinder test | Test sample met the requirements of the Specification in respect of Annex A   |
| 9. Letter plate                                   | None fitted   |

## Sample Selection.

The sample submitted for tests were selected using the PCP Scheme Document Specification.  
The sample was submitted for test mounted in a 75mm x 100mm timber subframe in accordance with the manufacturer's installation requirements.  
Sample manufactured by the client.

## Clause 5 Sequence of Tests.

The sequence of testing the sample followed that detailed in Clause 5 of BS 6375-1:2015.

## Clause 5 Performance Requirements.

The performance of the sample was assessed against the requirements detailed in Table 1 Exposure categories and classifications

Description of Sample. (Sample 1)

<b>Sample type -</b>	A three leaf glaze in open out hinged bi-fold door assembly with one master leaf and two folding sliding leaves, full glass infill and standard threshold	
<b>Material -</b>	Aluminium	
<b>Finish -</b>	Painted	
<b>Fittings -</b>	<b>Master door</b> A five point (D KT) locking (two hook bolts, two cams, one dead bolt) Fuhr espagnolette system with four pin hinges.	
<b>Handle and Cylinder -</b>	ACDV258 cylinder, key locking Mila Pro Secure handle	
<b>Handle and Cylinder -</b>	Yale ACCY50/503S 3* cylinder, key locking standard handle	
<b>Fittings -</b>	<b>Two Sliding leaves</b> A two point locking (two shoot bolts), twelve pin hinges and two rollers	
<b>Weathersealing -</b>	Doubled sealed plastic weather strips	
<b>Glass -</b>	Double glazed with 4-20-4 mm toughened glass sealed units	
<b>Glass retention system -</b>	Internal beads and gaskets	
<b>Sample dimensions -</b>	Overall - Length: 2700mm Master Leaves - Length: 880mm Salve Leaves - Length: 850mm	Height: 2570mm Height: 2510mm Height: 2510mm
<b>Date of test -</b>	06 September 2016	
<b>Laboratory temperature -</b>	25.3°C	
<b>Laboratory humidity -</b>	73.3%	

Elevation Drawing of Door Assembly.

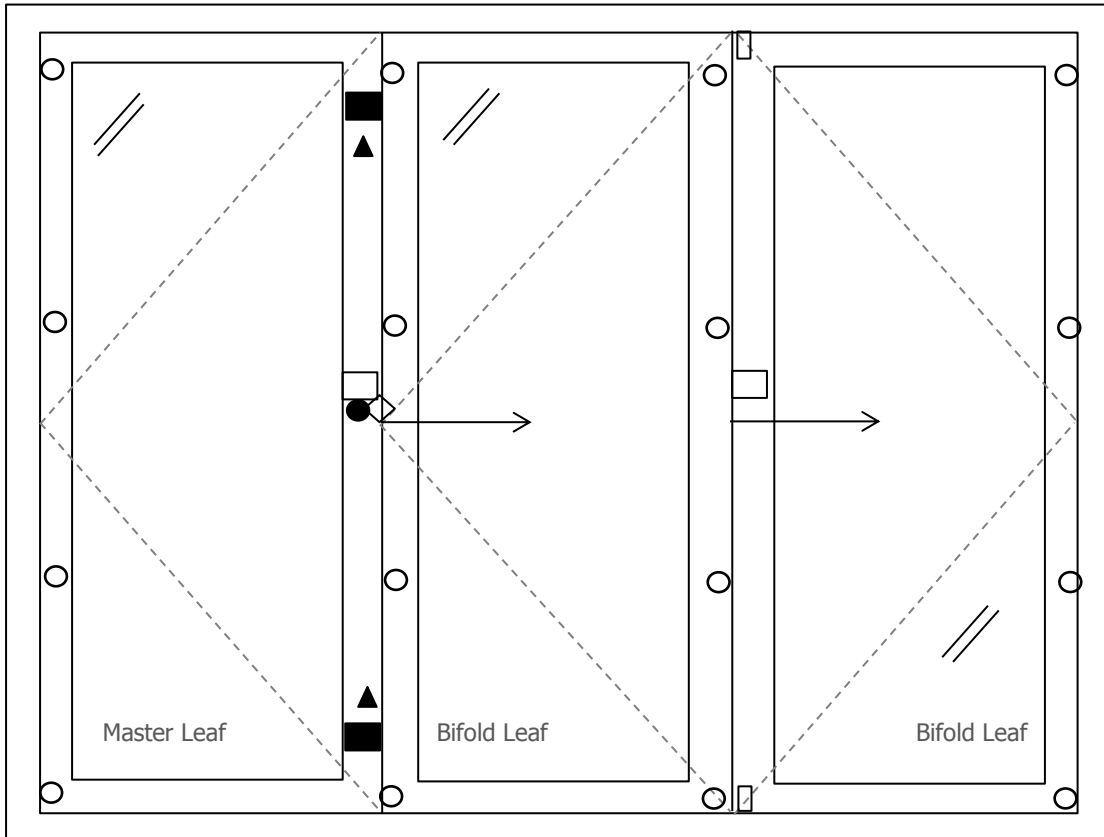

- - Handle
- - Hinge
- - Cylinder
- - Cam
- ▭ - Shoot Bolt
- ◇ - Dead Bolt
- ▲ - Hook Bolt



# Test Results.

## CLAUSE 7 PERFORMANCE REQUIREMENTS

## ASSESSMENT

### B.4.3 Manipulation Test

The sample was mounted, vertically and square, in the test rig as described in B.3.1.

The test was carried out in accordance with the given objective of this Annex using the procedure detailed in B.4.3.1 and the tools described in Group A and B where applicable.

The sample was closed and locked and the key removed.

Although there is no overall time limit no one technique was used for more than 3 minutes.

No tools were effective by any technique after 3 minutes

Pass

### B.4.4 Cutting and Infill medium removal test

#### B.4.4.2 Infill Manual Test

The sample was mounted, vertically and square, in the test rig as described in B.3.1.

The test was carried out in accordance with the requirements of this Annex using the tools described tools in Group A and B where applicable.

A craft knife was used to cut a 'V' in the profile. No entry was gained.

No entry could be effected within 3 minutes

Pass

#### B.4.4.3 Infill Mechanical Test

The sample was mounted, vertically and square, in the test rig as described in B.3.1.

The test was carried out with a perpendicular to plane load of 2.0kN applied to each corner of the glazing and each corner of the boundaries of components in turn as specified.

No evidence of bead failure

No entry could be effected

Pass

#### B.4.4.4 Manual Cutting Test

Not applicable

# Test Results (Continued).

## PERFORMANCE REQUIREMENTS

### B.4.5 Mechanical Loading Test

The sample was mounted, vertically and square, in the test rig.

The test was carried out in accordance with the procedures detailed in B.4.5, Using loading cases B.1 to B.6 and Figures B.12 for loading sequence and using the test apparatus detailed in Figures B.6 to B.9.

Diagram of points of application of loads

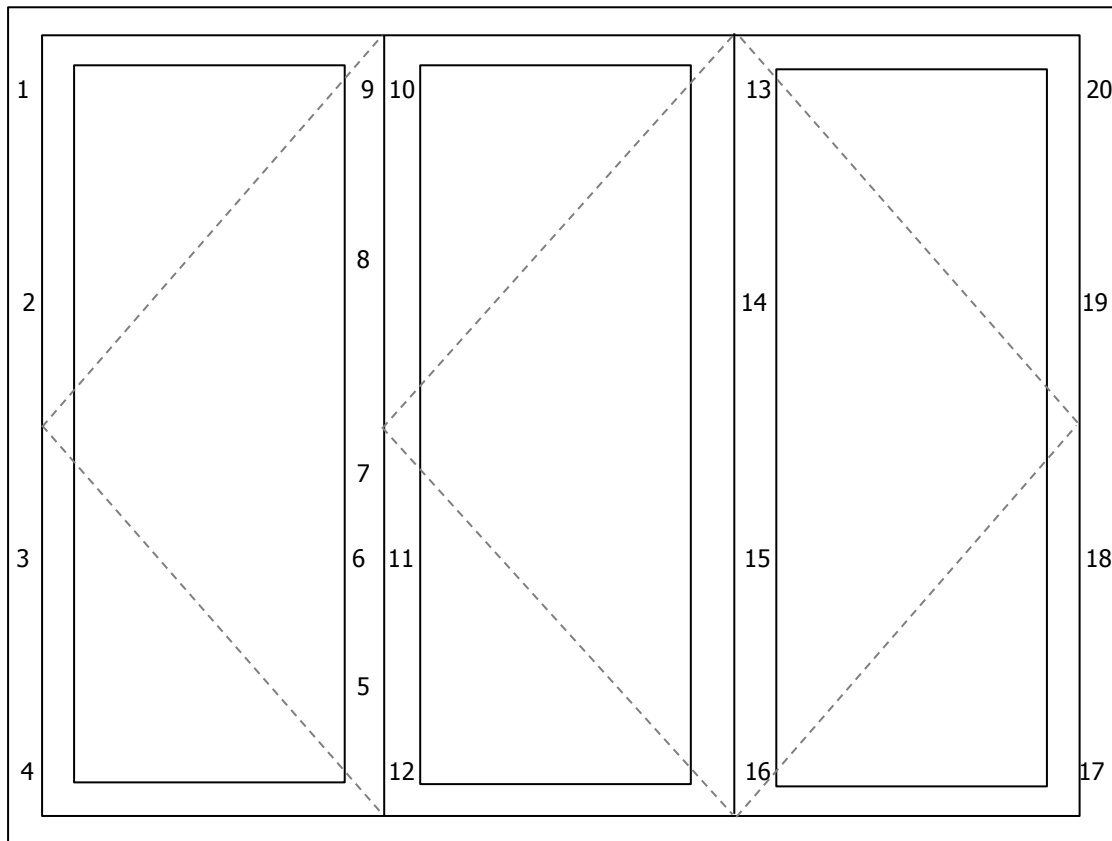

## Test Results (Continued).

### PERFORMANCE REQUIREMENTS

### ASSESSMENT

#### B.4.5 Mechanical Loading Test

##### B.4.5.2 Loading Procedures

Point of application of load

##### First Sequence

1. Hinge (head of left jamb)

Standard loading case used: 1

Load applied in plane: 1.5kN at right angles to the edge and towards the opposite edge

Load applied perpendicular to plane: 4.5kN applied for 10 seconds

2. Hinge (upper left jamb)

Standard loading case used: 1

Load applied in plane: 1.5kN at right angles to the edge and towards the opposite edge

Load applied perpendicular to plane: 4.5kN applied for 10 seconds

3. Hinge (lower left jamb)

Standard loading case used: 1

Load applied in plane: 1.5kN at right angles to the edge and towards the opposite edge

Load applied perpendicular to plane: 4.5kN applied for 10 seconds

4. Hinge (threshold of left jamb)

Standard loading case used: 1

Load applied in plane: 1.5kN at right angles to the edge and towards the opposite edge

Load applied perpendicular to plane: 4.5kN applied for 10 seconds

5. Cam (lower false mullion)

Standard loading case used: 8

Load applied in plane: 1.5kN along edge in a direction to disengage the cam

Load applied perpendicular to plane: 4.5kN applied for 10 seconds

Load applied in plane: 1.5kN at right angles to the edge and towards the opposite edge

1.5kN at the mullion to oppose the above load

Load applied perpendicular to plane: 4.5kN applied for 10 seconds

## Test Results (Continued).

### PERFORMANCE REQUIREMENTS

### ASSESSMENT

#### B.4.5 Mechanical Loading Test

##### B.4.5.2 Loading Procedures

Point of application of load

#### 6. Hook Bolt (lower false mullion)

Standard loading case used: 8

Load applied in plane: 1.5kN along edge in a direction to disengage the bolt

Load applied perpendicular to plane: 4.5kN applied for 10 seconds

Load applied in plane: 1.5kN at right angles to the edge and towards the opposite edge

1.5kN at the mullion to oppose the above load

Load applied perpendicular to plane: 4.5kN applied for 10 seconds

#### 7. Dead bolt (centre false mullion)

Standard loading case used: 9

Loads applied in plane: 1.5kN at right angles to the edge and away from the opposite edge

1.5kN at the mullion to oppose the above load

Load applied perpendicular to plane: 4.5kN applied for 10 seconds

#### 8. Hook Bolt / Hinge (upper false mullion)

Standard loading case used: 8 / 2

Load applied in plane: 1.5kN along edge in a direction to disengage the bolt

Load applied perpendicular to plane: 4.5kN applied for 10 seconds

Load applied in plane: 1.5kN at right angles to the edge and towards the opposite edge

1.5kN at the mullion to oppose the above load

Load applied perpendicular to plane: 4.5kN applied for 10 seconds

#### 9. Cam (upper false mullion)

Standard loading case used: 8

Load applied in plane: 1.5kN along edge in a direction to disengage the cam

Load applied perpendicular to plane: 4.5kN applied for 10 seconds

Load applied in plane: 1.5kN at right angles to the edge and towards the opposite edge

1.5kN at the mullion to oppose the above load

Load applied perpendicular to plane: 4.5kN applied for 10 seconds

## Test Results (Continued).

### PERFORMANCE REQUIREMENTS

### ASSESSMENT

#### B.4.5 Mechanical Loading Test

##### B.4.5.2 Loading Procedures

Point of application of load

#### 10. Roller / Hinge (upper false mullion)

Standard loading case used: 11/2

Load applied in plane: 1.5kN along edge in a direction to disengage the roller

Load applied perpendicular to plane: 1.5kN applied for 10 seconds

Load applied in plane: 1.5kN at right angles to the edge and towards the opposite edge

1.5kN at the mullion to oppose the above load

Load applied perpendicular to plane: 4.5kN applied for 10 seconds

#### 11. Hinge (lower false mullion)

Standard loading case used: 1

Load applied in plane: 1.5kN at right angles to the edge and towards the opposite edge

Load applied perpendicular to plane: 4.5kN applied for 10 seconds

#### 12. Roller / Hinge (lower false mullion)

Standard loading case used: 11/2

Load applied in plane: 1.5kN along edge in a direction to disengage the roller

Load applied perpendicular to plane: 1.5kN applied for 10 seconds

Load applied in plane: 1.5kN at right angles to the edge and towards the opposite edge

Load applied perpendicular to plane: 4.5kN applied for 10 seconds

#### 13. Shoot / Hinge (lower false mullion)

Standard loading case used: 5/2

Load applied in plane: 1.5kN along edge in a direction to disengage the shoot bolt

Load applied perpendicular to plane: 4.5kN applied for 10 seconds

Load applied in plane: 1.5kN at right angles to the edge and towards the opposite edge

Load applied perpendicular to plane: 4.5kN applied for 10 seconds

#### 14. Hinge (lower false mullion)

Standard loading case used: 1

Load applied in plane: 1.5kN at right angles to the edge and towards the opposite edge

Load applied perpendicular to plane: 4.5kN applied for 10 seconds

## Test Results (Continued).

### PERFORMANCE REQUIREMENTS

### ASSESSMENT

#### B.4.5 Mechanical Loading Test

##### B.4.5.2 Loading Procedures

Point of application of load

15. Hinge (upper false mullion)

Standard loading case used: 1

Load applied in plane: 1.5kN at right angles to the edge and towards the opposite edge

Load applied perpendicular to plane: 4.5kN applied for 10 seconds

16. Shoot / Hinge (upper false mullion)

Standard loading case used: 5/2

Load applied in plane: 1.5kN along edge in a direction to disengage the shoot bolt

Load applied perpendicular to plane: 4.5kN applied for 10 seconds

Load applied in plane: 1.5kN at right angles to the edge and towards the opposite edge

Load applied perpendicular to plane: 4.5kN applied for 10 seconds

17. Hinge (head of right jamb)

Standard loading case used: 1

Load applied in plane: 1.5kN at right angles to the edge and towards the opposite edge

Load applied perpendicular to plane: 4.5kN applied for 10 seconds

18. Hinge (upper right jamb)

Standard loading case used: 1

Load applied in plane: 1.5kN at right angles to the edge and towards the opposite edge

Load applied perpendicular to plane: 4.5kN applied for 10 seconds

19. Hinge (lower right jamb)

Standard loading case used: 1

Load applied in plane: 1.5kN at right angles to the edge and towards the opposite edge

Load applied perpendicular to plane: 4.5kN applied for 10 seconds

20. Hinge (threshold of right jamb)

Standard loading case used: 1

Load applied in plane: 1.5kN at right angles to the edge and towards the opposite edge

Load applied perpendicular to plane: 4.5kN applied for 10 seconds

No entry effected

Pass

# Test Results (Continued).

## PERFORMANCE REQUIREMENTS

### B.4.8 Soft Body Impact Test

### ASSESSMENT

The sample was mounted, vertically and square, in the test rig as described in B.3.1.

The test was carried out in accordance with the requirements, objectives and procedures detailed in B.4.8.1 using the impact point and procedure described in B.4.8.2 and B.4.8.3 and Figure B.10

Diagram of points of application of loads

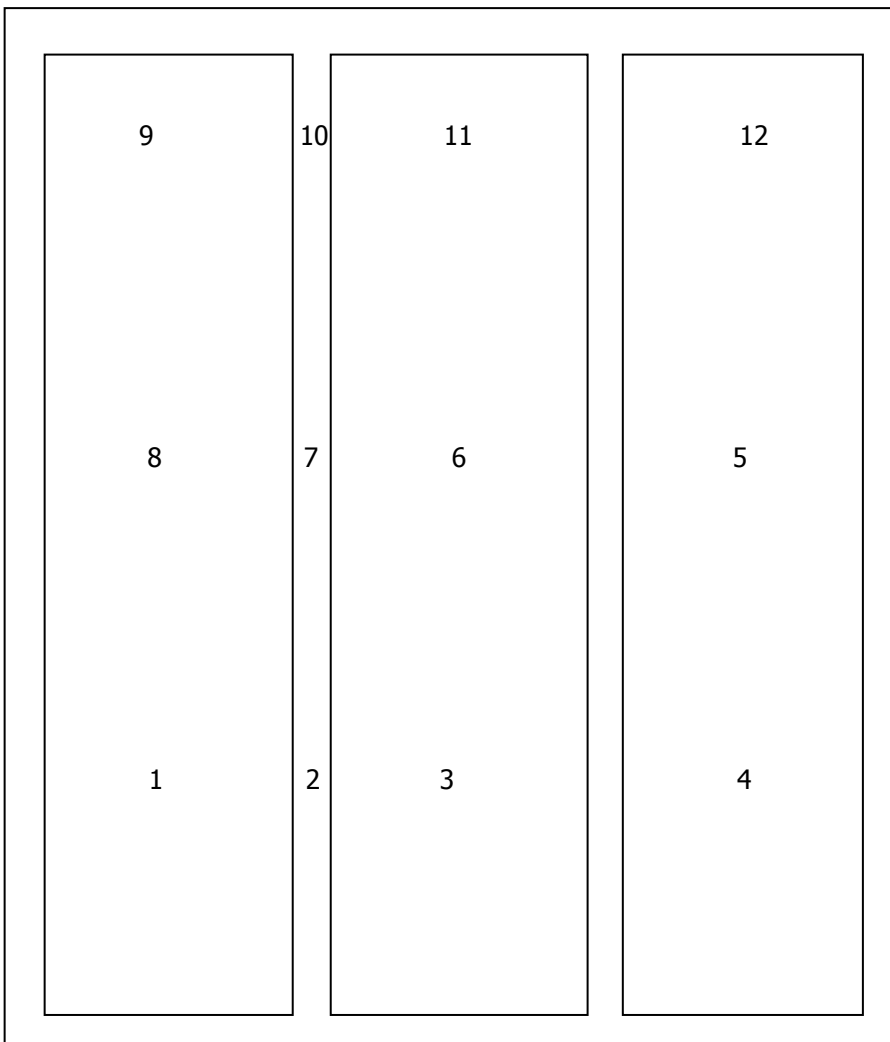

## Test Results (Continued).

### PERFORMANCE REQUIREMENTS

#### B.4.8 Soft Body Impact Test

#### ASSESSMENT

Impact point	Position from floor level	Effect
1	0.80m	None
2	0.80m	None
3	0.80m	None
4	0.80m	None
5	1.25m	None
6	1.25m	None
7	1.25m	None
8	1.25m	None
9	1.70m	None
10	1.70m	None
11	1.70m	None
12	1.70m	None

No entry effected

Pass



## Test Results (Continued).

### PERFORMANCE REQUIREMENTS

#### B.4.9 Hard body impact test

The sample was mounted, vertically and square, in the test rig as described in B.3.1.

The test was carried out in accordance with the requirements, objectives and procedures detailed in B.4.9.1, B.4.9.2.1, B.4.9.2.2, B.4.9.2.3 using procedure B.4.9.3, using the test apparatus detailed in B.11 using the impact sequence in figure B.14.

Diagram of points of application of loads

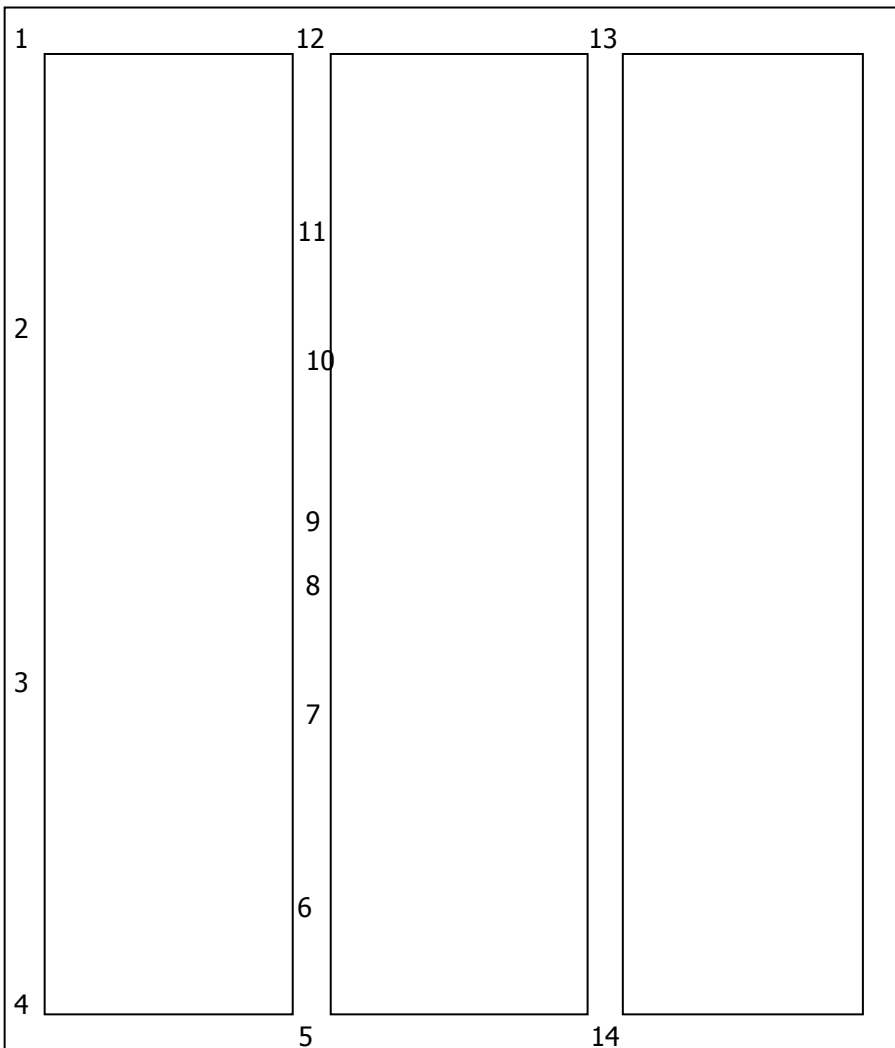

## Test Results (Continued).

### ASSESSMENT

#### PERFORMANCE REQUIREMENTS

##### B.4.9 Hard body impact test (continued)

Impact point	Position	Effect
1	Corner/Hinge	None
2	Hinge	None
3	Hinge	None
4	Corner Hinge	None
5	Corner/ Hinge / Roller	None
6	Cam	None
7	Hook	None
8	Cylinder	None
9	Dead Bolt/ Hinge	None
10	Hook Bolt/Hinge	None
11	Cam	None
12	Corner/ Roller/ Hinge	None
13	Shoot Bolt	None
14	Shoot bolt	None

No entry effected

Pass

## Test Results (Continued).

### PERFORMANCE REQUIREMENTS

### ASSESSMENT

#### B.4.6 Manual Check Test

The sample was mounted, vertically and square, in the test rig as described in B.3.1.

The test was carried out in accordance with the given objective of this Clause using the procedure detailed in B.4.6.3 and the tools described in B.4.6.2.

No one technique was used for more than 3 minutes.

No alternative method of entry could be effected within 3 minutes

Pass

#### B.4.7 Additional Loading Test

Not applicable as an alternative method of entry was not identified

## Test Results (Continued).

### PERFORMANCE REQUIREMENTS

### ASSESSMENT

**Hardware** - ACDV258 cylinder with key locking Mila Pro Secure handle

#### **Annex A Security Hardware and Cylinder Test and Assessment**

##### **Annex A.3.2 (Part 1)**

The sample was mounted, vertically and square, in the test rig as described in Clause 3.1.

The test was carried out in accordance with the given objective of this Annex using the procedure detailed in Annex A.3.1 and the tools described in A.2.

The sample was closed and locked and the key removed.

Mole grips were used to snap the cylinder

The total attack time was 3 minutes and the total rest time was 7 minutes

No entry could be effected within 3 minutes

Pass

##### **Annex A.3.2 (Part 2)**

The sample was mounted, vertically and square, in the test rig as described in Clause 3.1.

The test was carried out in accordance with the given objective of this Annex using the procedure detailed in Annex A.3.1 and the tools described in A.2

The sample was closed and locked and the key removed.

The total attack time was 3 minutes and the total rest time was 7 minutes

No entry could be effected within 3 minutes

Pass

## Test Results (Continued).

### PERFORMANCE REQUIREMENTS

### ASSESSMENT

**Hardware** – Yale ACCY50/503S 3\* cylinder with key locking standard handle

#### **Annex A Security Hardware and Cylinder Test and Assessment**

##### **Annex A.3.2 (Part 1)**

The sample was mounted, vertically and square, in the test rig as described in Clause 3.1.

The test was carried out in accordance with the given objective of this Annex using the procedure detailed in Annex A.3.1 and the tools described in A.2.

The sample was closed and locked and the key removed.

Mole grips were used to snap the cylinder

The total attack time was 3 minutes and the total rest time was 7 minutes

No entry could be effected within 3 minutes

Pass

##### **Annex A.3.2 (Part 2)**

The sample was mounted, vertically and square, in the test rig as described in Clause 3.1.

The test was carried out in accordance with the given objective of this Annex using the procedure detailed in Annex A.3.1 and the tools described in A.2

The sample was closed and locked and the key removed.

The total attack time was 3 minutes and the total rest time was 7 minutes

No entry could be effected within 3 minutes

Pass

#### **B.4.3 Letter Plates**

None fitted

Photograph of Sample.

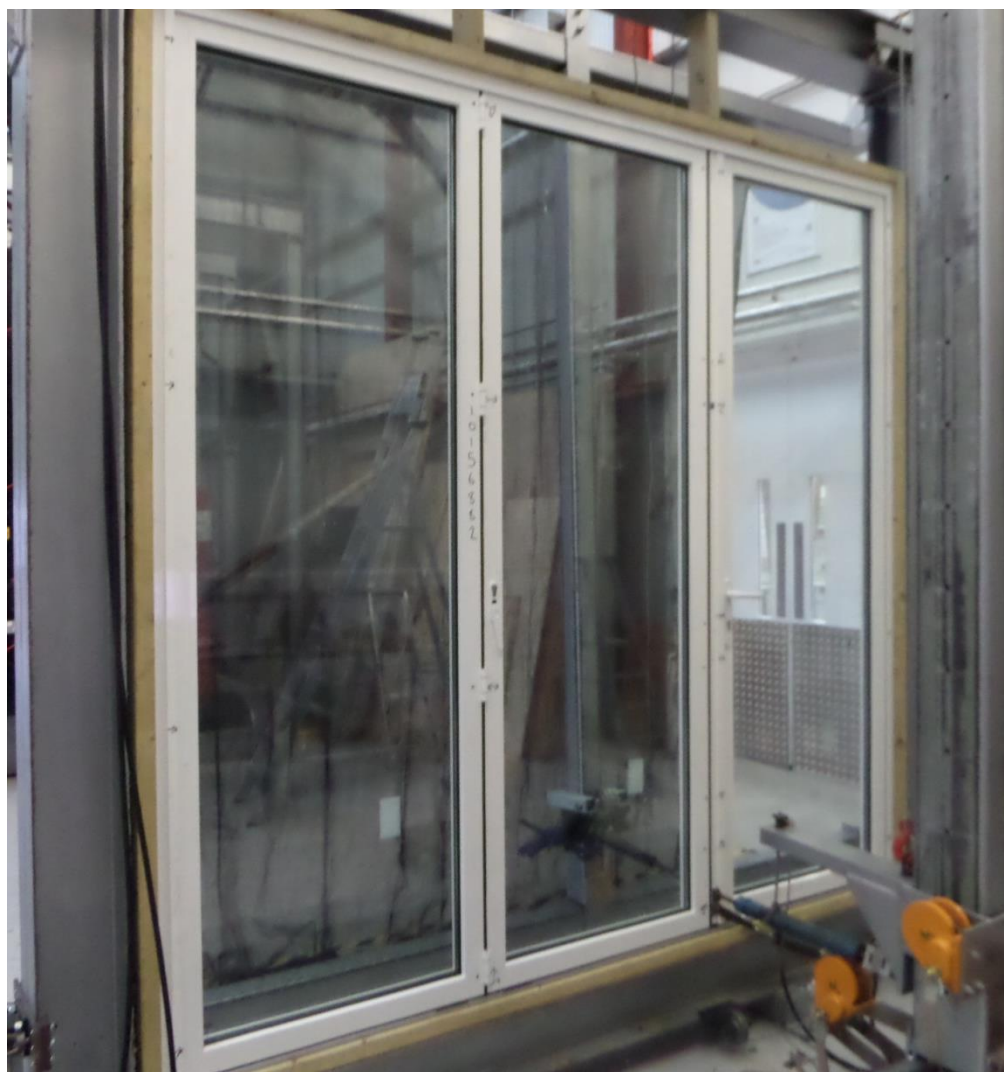

## BS4873:2009 Type Test.

### Product Description (Weather Test)

1 off three leaf glaze in open out hinged bi-fold door assembly with one master leaf and two folding sliding leaves, full glass infill and low threshold (Sample 2)

1 off three leaf glaze in open in hinged bi-fold door assembly with one master leaf and two folding sliding leaves, full glass infill and low threshold (Sample 3)

1 off three leaf glaze in open out hinged bi-fold door assembly with one master leaf and two folding sliding leaves, full glass infill and standard threshold (Sample 4)

1 off three leaf glaze in open in hinged bi-fold door assembly with one master leaf and two folding sliding leaves, full glass infill and standard threshold (Sample 5)

(Sample ID No 10156882)

Date samples received: 31 August 2016

### Test Results.

- |                     |   |
|---------------------|---|
| 1. Air permeability | Test samples 2, 3, 4 and 5 met the requirements of the Specification, in respect of Clause 13, for Test Pressure Class 1.   |
| 2. Watertightness   | <p>Test sample 2 met the requirements of the Specification, in respect of Clause 13, for Test Pressure Class 2A.</p> <p>Test sample 3 met the requirements of the Specification, in respect of Clause 13, for Test Pressure Class 3A.</p> <p>Test sample 4 met the requirements of the Specification, in respect of Clause 13, for Test Pressure Class 4A.</p> <p>Test sample 5 met the requirements of the Specification, in respect of Clause 13, for Test Pressure Class 8A.</p> |
| 3. Wind resistance  | Test samples 2, 3 and 4 met the requirements of the Specification, in respect of Clause 8, for Exposure Category Class A2.  |

### Classification for Wind Resistance.

Test sample 3	Exposure Category 800Pa
---------------	-------------------------

- |                         |   |
|-------------------------|---|
| 4. Operational Strength | Test sample 3 met the requirements of the Specification in respect of BS 6375-2 |
|-------------------------|---|

## Classification for Operational strength.

Operating forces	Class 1
Vertical load	Class 2
Resistance to Static torsion	Class 2
Soft and Heavy body Impact Load bearing	Class 2
Hard body impact	Class 2
Load bearing capacity of safety devices	N/A
Closure against obstruction	Pass

5. Basic security                      Test sample 3 met the requirements of BS6375-3

## Sample Selection.

The sample submitted for tests were selected using the PCP Scheme Document Specification. The sample was submitted for test mounted in a 75mm x 100mm timber subframe in accordance with the manufacturer's installation requirements. Sample manufactured by the client.

## Clause 5 Sequence of Tests.

The sequence of testing the sample followed that detailed in Clause 5 of BS 6375-1:2015.

## Clause 5 Performance Requirements.

The performance of the sample was assessed against the requirements detailed in Table 1 Exposure categories and classifications



## Methods Of Test.

### 1. **Operating Forces**

The operating forces acting on the sample were determined by the methods given in standard BS EN 12046 – 2.

### 2. **Air Permeability**

The air permeability of the sample was determined by the method given in BS 6375-1:2015.

### 3. **Watertightness**

The watertightness of the sample was determined by the method given in BS 6375-1:2015.

### 4. **Wind Resistance**

The wind resistance of the samples was determined by the methods (P1 and P2) given in BS 6375-1:2015.

### 5. **Repeat Tests**

After testing for resistance to wind loading (P1 and P2) the air permeability test was repeated.

### 6. **Wind Resistance**

The wind resistance of the samples was determined by the method (P3) given in BS 6375-1:2015.

### 7. **Resistance to Vertical Loads**

The resistance to vertical loads test was carried out using the method given in standard BS EN 947.

### 8. **Resistance to Static Torsion**

The resistance to static torsion test was carried out using the method given in standard BS EN 948.

### 9. **Soft and heavy body impact**

The resistance to soft and heavy body impact was carried out using the method given in standard BS EN 949.

### 10. **Hard body impact**

The resistance to hard body impact was carried out using the method given in standard BS EN 950.

### 11. **Closure against obstruction**

The Closure against obstruction was carried out using the method given in BS 6375-3

## Methods Of Test (Continued).

### 12. **Basic security**

The basic security test was carried out using the method given in standard BS 6375:3.

### Note.

Basic Security not UKAS accredited to BS6375-3

## Description of Sample. (Sample 2)

<b>Sample type -</b>	A three leaf glaze in open out hinged bi-fold door assembly with one master leaf and two folding sliding leaves, full glass infill and low threshold	
<b>Material -</b>	Aluminium	
<b>Finish -</b>	White	
<b>Fittings -</b>	<p><b>Master door</b> A five point locking (two hook bolts, two cams, 1 dead bolt) Fuhr espagnolette system, ACDV258 cylinder, key locking Mila Pro Secure handle and four pin hinges.</p> <p><b>Two Sliding leaves</b> A two point locking (two shoot bolts), twelve pin hinges and two rollers</p>	
<b>Weathersealing -</b>	Doubled sealed plastic weather strips	
<b>Glass -</b>	Double glazed with 4-20-4 mm toughened glass sealed units	
<b>Glass retention system -</b>	Internal beads and gaskets	
<b>Sample dimensions -</b>	Overall - Length: 3740mm Master Leaves - Length: 1200mm Slave Leaves - Length: 1200mm	Height: 2570mm Height: 2500mm Height: 2500mm
<b>Date of test -</b>	06 September 2016	
<b>Laboratory temperature -</b>	22.4°C	
<b>Laboratory humidity -</b>	69.7%	
<b>Laboratory Atmospheric Pressure -</b>	100.1kPa	

### Elevation Drawing of Door Assembly.

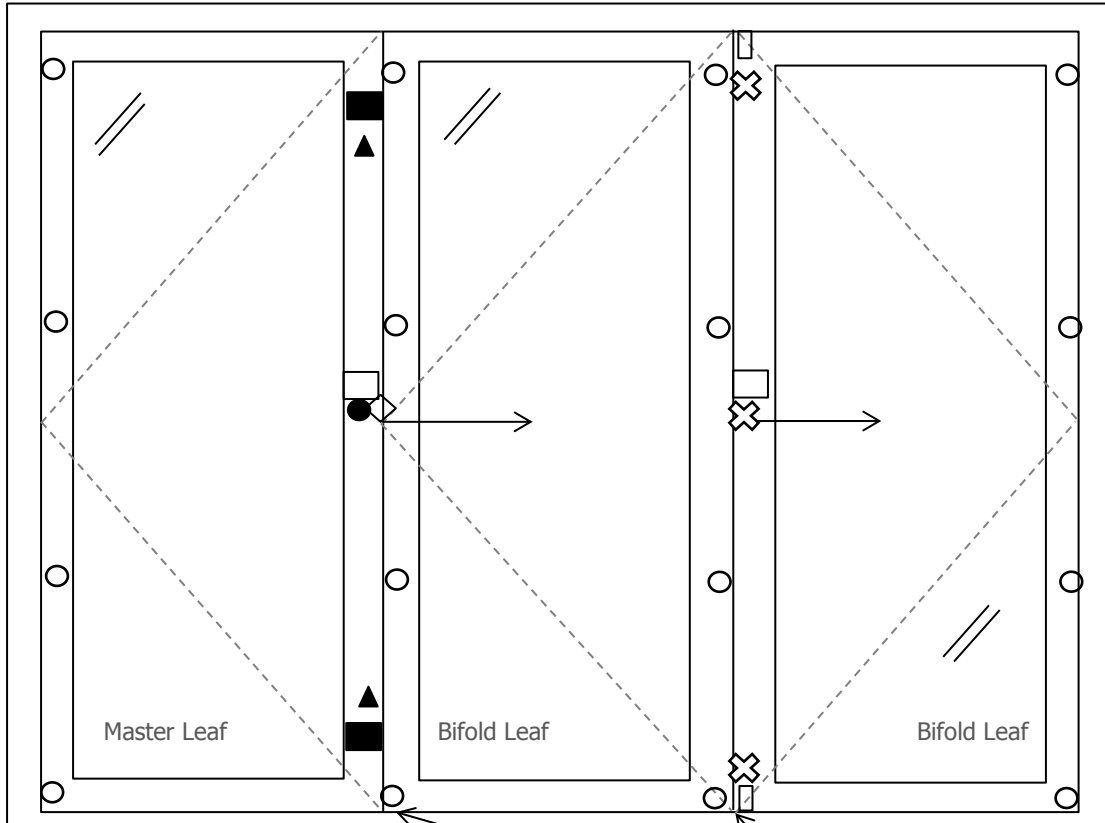

- - Handle
  - - Hinge
  - - Cylinder
  - - Cam
  - ▭ - Shoot Bolt
  - ◇ - Dead Bolt
  - ▲ - Hook Bolt
- Water Leakage Points
- Transducer Placement - X

### Graph of Air Permeability Before Gusting.

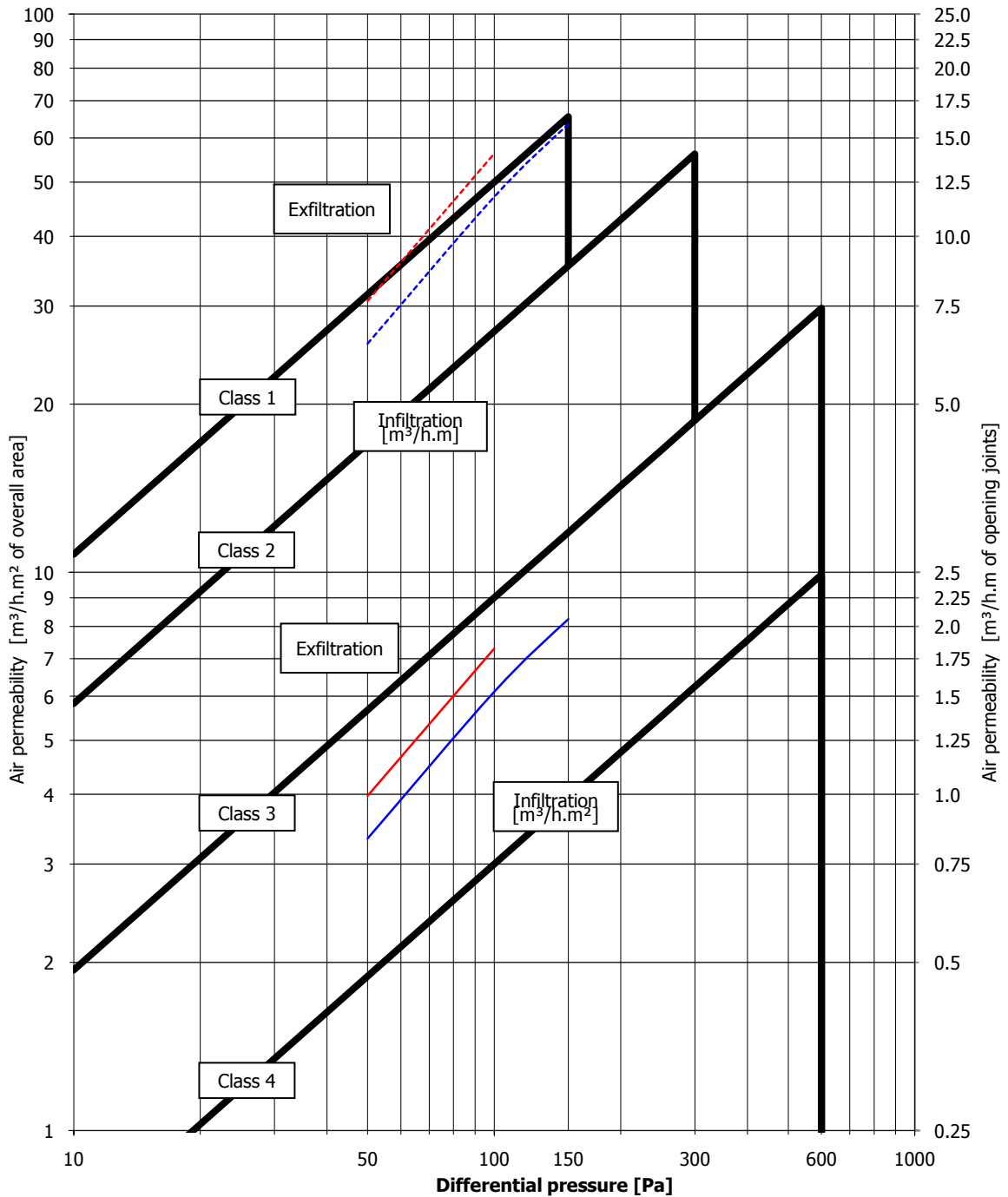

## Table of Air Permeability Before Gusting.

### AIR PERMEABILITY TEST RESULTS - BS 6375-1:2015 / BS EN 1026:2000

#### Clause 6.3 - Before resistance to wind tests

Three positive pressure pulses of 660Pa were applied prior to testing

Air Pressure [Pa]	Average rate of air leakage [m <sup>3</sup> /h]	Average rate of air leakage per meter length of opening joint [m <sup>3</sup> /h.m]	Average rate of air leakage relative to area of sample [m <sup>3</sup> /h.m <sup>2</sup> ]
50	35.1	2.05	3.66
100	64.4	3.76	6.71
150	89.7	5.24	9.33
200	-	-	-
250	-	-	-
300	-	-	-
450	-	-	-
600	-	-	-

Note: The figures in the table above give the leakage as an average of the leakage at positive pressure and the leakage at negative pressure

Total opening perimeter = 17.12m

Overall area = 9.61m<sup>2</sup>

BS 6375-1:2015 Clause 6.3 - Joint class = 1

BS 6375-1:2015 Clause 6.3 - Area class = 1

BS 6375-1:2015 Clause 6.3 - Overall class = 1

# Graph of Average Air Permeability Before Gusting.

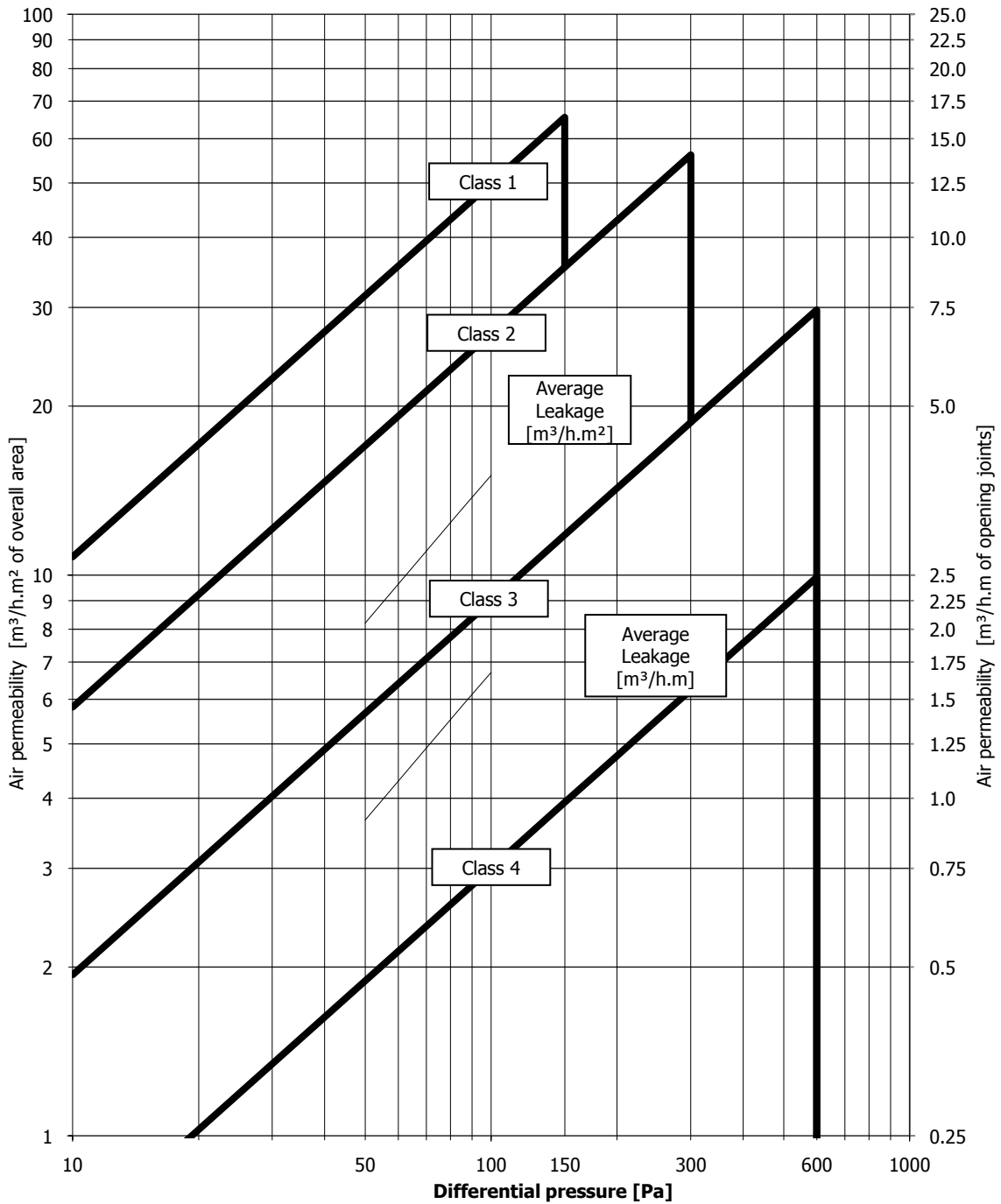

## Watertightness Test Results.

BS EN 1027:2000 Clause 7 Watertightness before resistance to wind loads

TABLE 2 - Spraying method 1A

Pressure (Pascals)	Point and time at which water leakage occurred
0	No leakage
50	No leakage
100	Water leaked from threshold opening joint onto sill at 1 minutes and 10 seconds
150	-
200	-
250	-
300	-
450	-
600	-
750	-
900	-
1050	-

### WIND LOAD RESISTANCE TEST RESULTS - BS EN 12211:2000

#### Clause 8 Resistance to wind load

##### P1 DEFLECTION TEST

Three positive pressure pulses at 880Pa were applied

No visible failures or functional defects to the test sample were observed after wind loads applied at a positive air pressure of 800Pa.

Actual deflection – 10.36mm (maximum deflection allowed 15.66mm)

Deflection/span ratio 1/226 (maximum ratio allowed 1/150)

Three negative pressure pulses at 880Pa were applied

No visible failures or functional defects to the test sample were observed after wind loads applied at a negative air pressure of 800Pa.

Actual deflection – 7.23mm (maximum deflection allowed 15.66mm)

Deflection/span ratio 1/325 (maximum ratio allowed 1/150)



**P2 REPEATED PRESSURE TEST**

No visible failures or functional defects to the test sample were observed after 50 cycles of repeated wind loads applied at a positive air pressure of 400Pa.

No visible failures or functional defects to the test sample were observed after 50 cycles of repeated wind loads applied at a negative air pressure of 400Pa.

In accordance with BS 6375-1:2015 Clause 6.5, as the classification after the resistance to wind load tests is the same as the classification before the resistance to wind load tests, the resulting classification for the sample is Class 1. (see following Table).

### Graph of Air Permeability After Gusting.

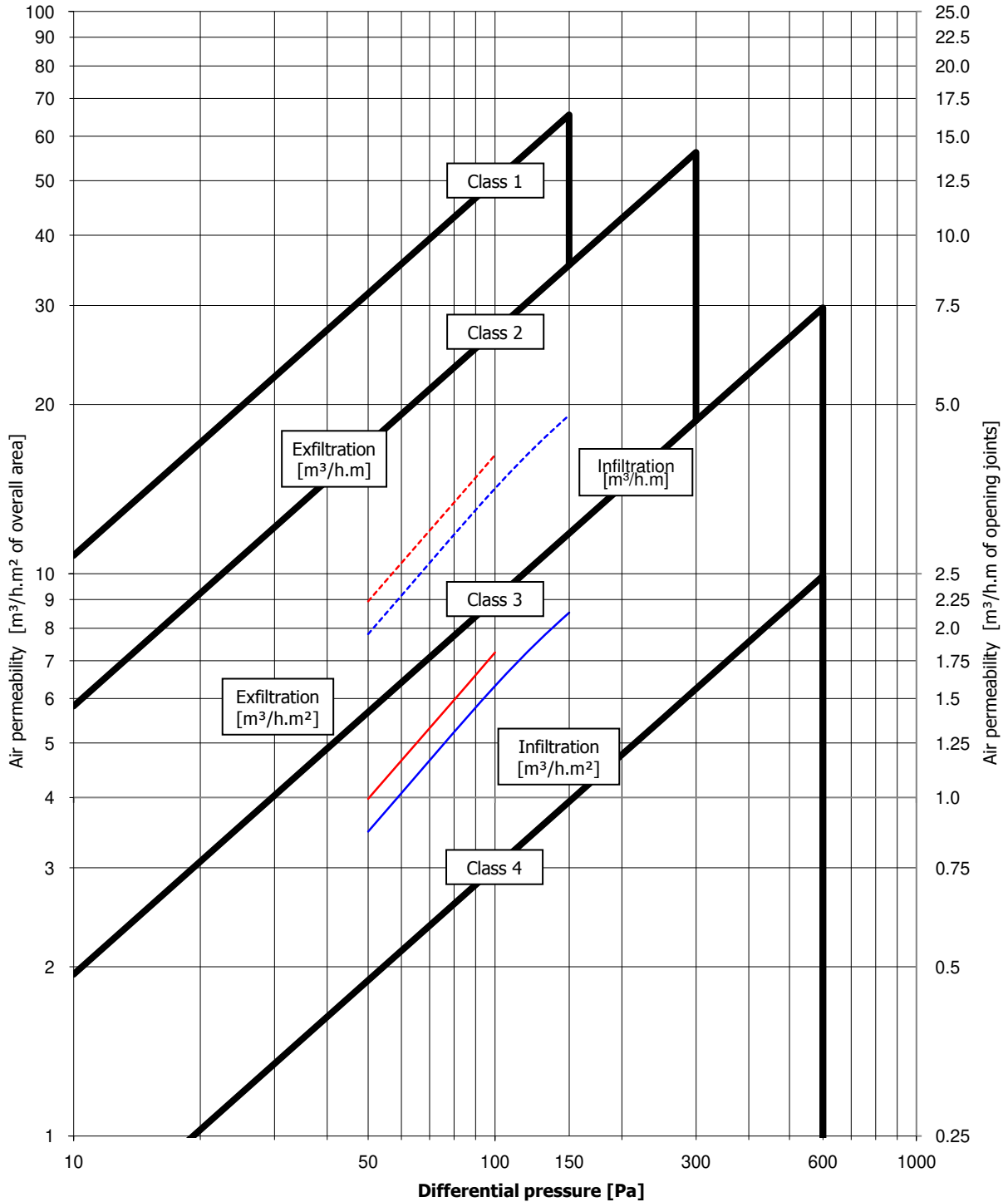

## Table Average Air Permeability After Gusting.

### AIR PERMEABILITY TEST RESULTS - BS 6375-1:2015 / BS EN 1026:2000

#### Clause 6.5 - After resistance to wind tests

Three positive pressure pulses of 660Pa were applied prior to testing

Air Pressure [Pa]	Average rate of air leakage [m <sup>3</sup> /h]	Average rate of air leakage per meter length of opening joint [m <sup>3</sup> /h.m]	Average rate of air leakage relative to area of sample [m <sup>3</sup> /h.m <sup>2</sup> ]
50	35.8	2.09	3.73
100	65.1	3.80	6.78
150	91.3	5.33	9.50
200	-	-	-
250	-	-	-
300	-	-	-
450	-	-	-
600	-	-	-

Note: The figures in the table above give the leakage as an average of the leakage at positive pressure and the leakage at negative pressure

Total opening perimeter = 17.12m

Overall area = 9.61m<sup>2</sup>

BS 6375-1:2015 Clause 6.5 - Joint class = 1

BS 6375-1:2015 Clause 6.5 - Area class = 1

BS 6375-1:2015 Clause 6.5 - Overall class = 1

In accordance with BS 6375-1:2015 Clause 6.5, as the classification after the resistance to wind load tests is the same as the classification before the resistance to wind load tests, the resulting classification for the sample is Class 1.

## Graph of Average Air Permeability After Gusting.

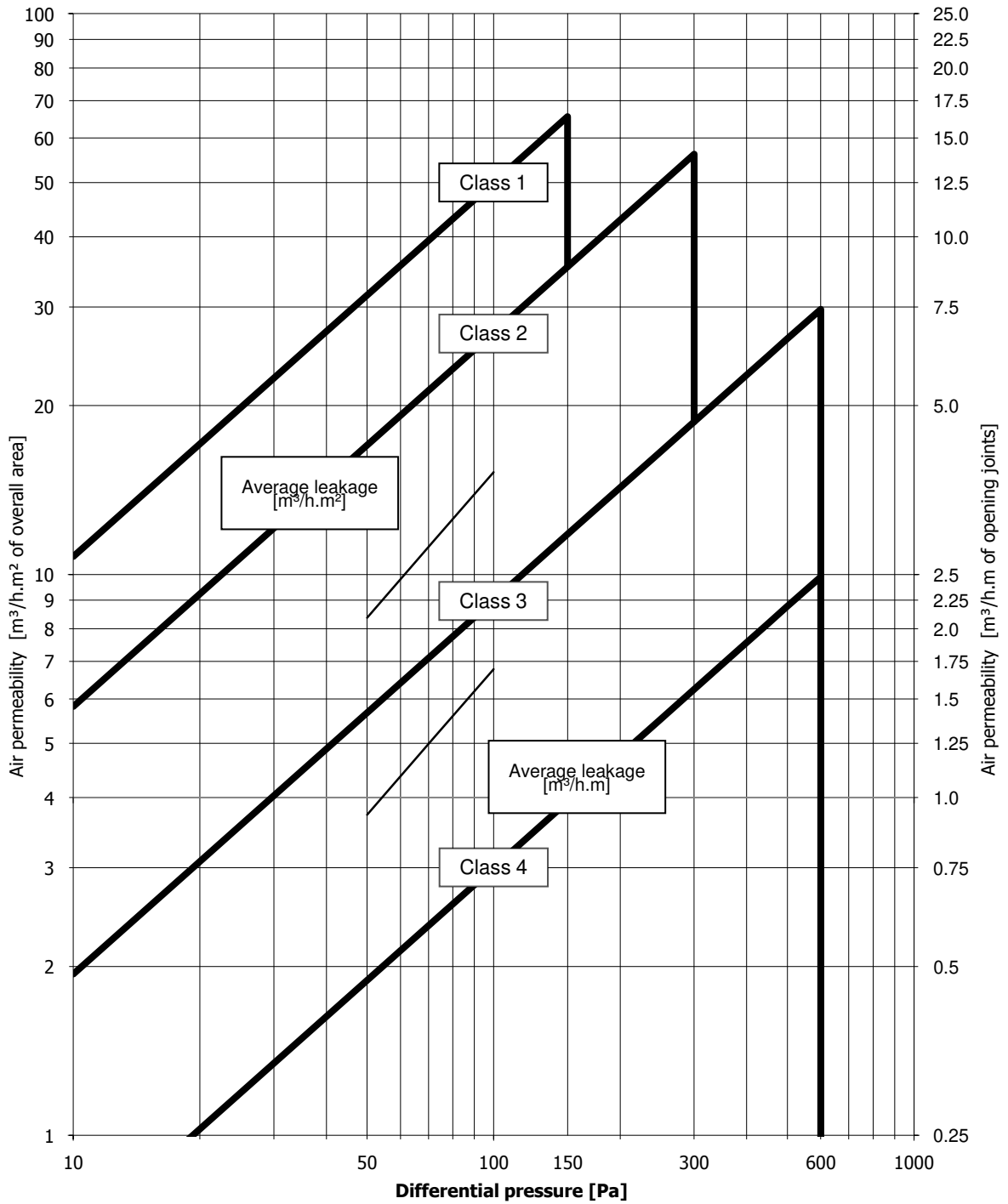

### Graph of Average Air Permeability After Gusting Including +20% Lines for Each Class.

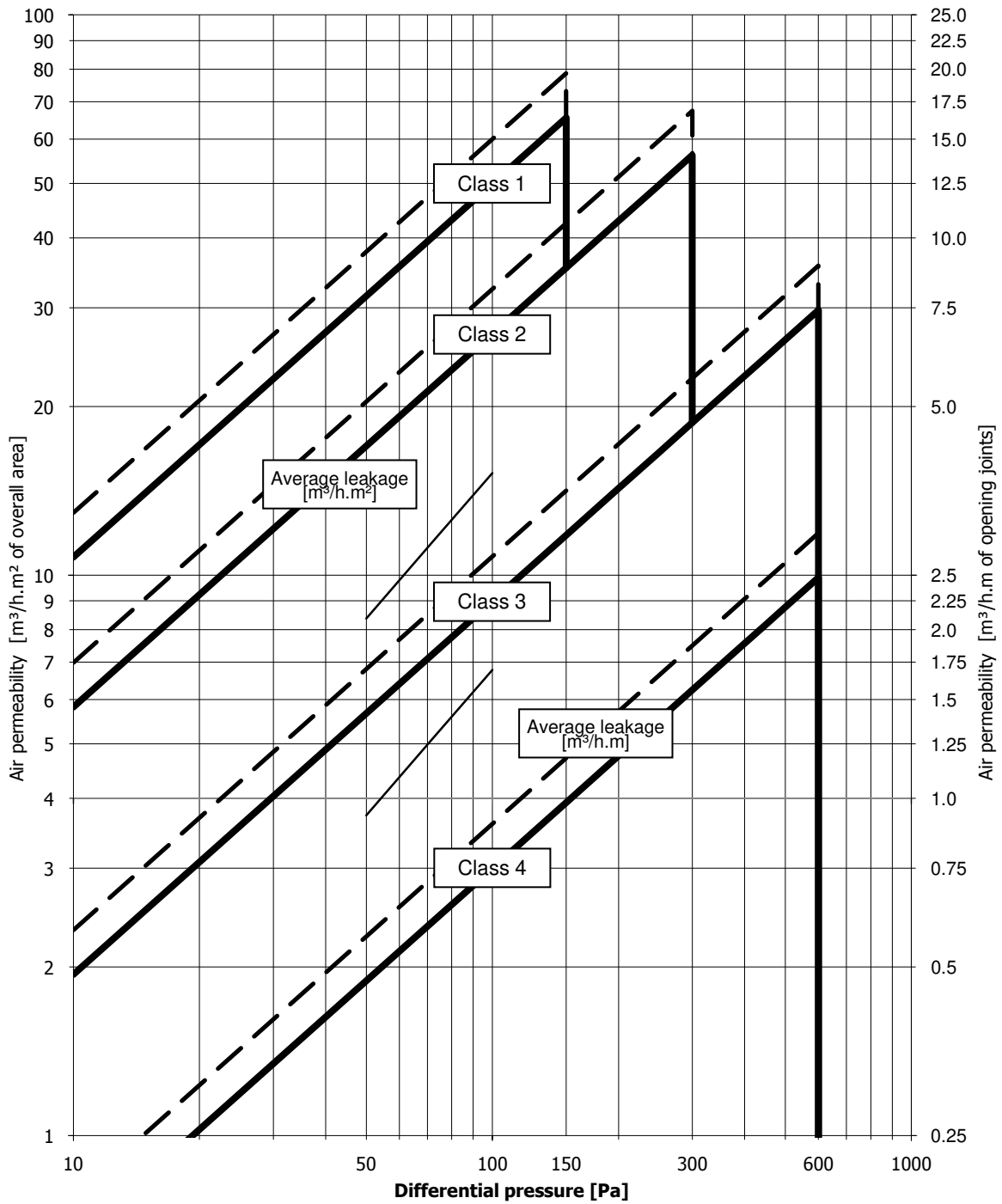

## Wind Load Resistance Test Results - BS EN 12211:2000.

### **P3 SAFETY TEST**

No parts of the test sample became detached and the test sample remained closed after a wind load safety test applied at a positive air pressure of 1200Pa.

No parts of the test sample became detached and the test sample remained closed after a wind load safety test applied at a negative air pressure of 1200Pa

## BS 6375-2:2009.

### Clause 6

#### Performance characteristics and requirements for pedestrian doorsets

#### Assessment

Clause 6.2 Operating Forces: EN12046-2 and EN12217

The sample was tested three times, closing the leaf, handle, locking the key, unlocking the key, handle opening and maintaining the leaf to stay open, and highest of the three results were then recorded.

Closing leaf force – 38.65N (maximum 75N)	Pass
Handle closing – 60.45N (maximum 100N)	Pass
Key torque to lock – 0.10Nm (maximum 20N)	Pass
Key torque to unlock – 0.10Nm (maximum 20N)	Pass
Handle opening – 63.05 (maximum 100N)	Pass
Force to maintain opening – 42.30N (maximum 75N)	Pass

### Clause 6.3.1 Vertical Load.

All loads were applied and removed in increments of maximum 100N.

The diagonal measurement of door was measured to the nearest 1mm (hinge bottom to lockside top corner)

A pre-load of  $200 \pm 4$ N using weights vertically to the top of the lock side corner of the door leaf, at  $50 \pm 5$ mm from the opening edge, and maintained for  $60 \pm 5$ s, then removed and left to rest for a further  $60 \pm 5$ s.

The gauge was zeroed then to the same loading point (Class 2) 600N was applied for  $300s \pm 5s$ , a maximum deformation measurement was taken

The load was removed and after  $180 \pm 5$ s the residual deflection measurement was taken, along with the diagonal measurement.

Pre diagonal measurement -	2655mm
Maximum deformation –	0.20mm
Residual measurement –	0.00mm
Diagonal measurement –	2655mm

For the door to pass, the residual deformation must not exceed 1.0mm Pass

**BS 6375-2:2009.****Clause 6****Performance characteristics and requirements for pedestrian doorsets****Assessment**

Clause 6.3.2 Resistance to static torsion.

All loads were applied and removed in increments of maximum 100N.

The door leaf was opened to 90° then fixed at the top lockside corner, 50± 5mm from the edge.

A pre-load of 200± 4N was applied horizontally and normally to the plane of the leaf, at the lower lockside corner, at 50± 5mm from the edge, then maintained for 60± 5s.

After 1 minute the gauge was zeroed and loaded to (Class 2) 250N for 300s ± 5s, the maximum deformation was taken, the load was taken off and left to rest for 180s ± 5s, the residual measurement was then taken.

Maximum deformation – 34.30mm

Residual measurement – 0.00mm

For the door to pass the residual deformation must not exceed 2.0mm

Pass

**Clause 6.3.3 Soft and Heavy body Impact .**

The door was closed to its normal operating mode and the sample was marked at the centre of the door leaf.

The deviation across the width of the door was measured at the impact point.

A 30±0.6Kg leather impactor was raised to the required drop height and impacted to the exterior face, then the deviation was measured again

For the door to achieve the required class it shall not exceed 2mm Residual measurement across face of impacted side.

The sample was impacted in the centre of the active leaf and from the outside

Residual measurement – 0mm

Pass



**BS 6375-2:2009.****Clause 6****Performance characteristics and requirements for pedestrian doorsets****Assessment**

Clause 6.3.4 Hard body Impact.

The door leaf was mounted horizontally with rigid supports under the long edges of the leaf and pattern 2 was selected.

Glazed impact points were omitted, and the exterior side was impacted.

If permanent damage is left after impact measurements were taken after 30 minutes.

Mean of the Diameter – 3.00mm

Mean of the depth – 0.10m

The mean to qualify for a class shall not exceed 20mm, and the mean for the depth shall not exceed 1.0mm

Pass

**Clause 6.4 Load bearing capacity of safety devices.**

Not assessed due to no safety device being fitted

**Closure against obstruction.**

The objective of this test is to determine the resistance of a doorset to closure of the door leaf against small objects such as small toys, which may be accidentally trapped between the frame and leaf.

A 50 x 50 x 10mm aluminium block was placed in the gap between the leaf and the bottom of the hinge side jamb.

A 200N force was applied to the lock side of the leaf and held for 15 ±5 seconds

The leaf was then opened and closed 5 times and the operating forces were taken

Pass

**BS 6375-2:2009.****Clause 6****Performance characteristics and requirements for pedestrian doorsets****Assessment**

Clause 6.2 Operating Forces: EN12046-2 and EN12217

The sample was tested three times, closing the leaf, handle, locking the key, unlocking the key, handle opening and maintaining the leaf to stay open, and highest of the three results were then recorded.

Closing leaf force – 40.50N (maximum 75N)	Pass
Handle closing – 61.60N (maximum 100N)	Pass
Key torque to lock – 0.10Nm (maximum 20N)	Pass
Key torque to unlock – 0.10Nm (maximum 20N)	Pass
Handle opening – 66.60N (maximum 100N)	Pass
Force to maintain opening – 41.25N (maximum 75N)	Pass

**Basic security (Annex A) .****BS 6375: Part 3: 2009 - Performance of Doors**

The objective of this test is to establish from if from the outside entry can be gained by defeating the glazing or locking system.

The force used did not result in permanent set or plastic deformation of any tool.

Damaged tools shall be replaced and the test did not exceed the maximum 3 minute time period.

The screwdriver was used to no effect

No entry could be effected Pass

## Description of Sample. (Sample 3)

<b>Sample type -</b>	A three leaf glaze in open in hinged bi-fold door assembly with one master leaf and two folding sliding leaves, full glass infill and low threshold	
<b>Material -</b>	Aluminium	
<b>Finish -</b>	White	
<b>Fittings -</b>	<p><b>Master door</b> A five point locking (two hook bolts, two cams, 1 dead bolt) Fuhr espagnolette system, ACDV258 cylinder, key locking Mila Pro Secure handle and four pin hinges.</p> <p><b>Two Sliding leaves</b> A two point locking (two shoot bolts), twelve pin hinges and two rollers</p>	
<b>Weathersealing -</b>	Doubled sealed plastic weather strips	
<b>Glass -</b>	Double glazed with 4-20-4 mm toughened glass sealed units	
<b>Glass retention system -</b>	Internal beads and gaskets	
<b>Sample dimensions -</b>	Overall - Length: 3740mm Master Leaves - Length: 1200mm Slave Leaves - Length: 1200mm	Height: 2570mm Height: 2500mm Height: 2500mm
<b>Date of test -</b>	7 September 2016	
<b>Laboratory temperature -</b>	22.4°C	
<b>Laboratory humidity -</b>	69.7%	

### Elevation Drawing of Door Assembly.

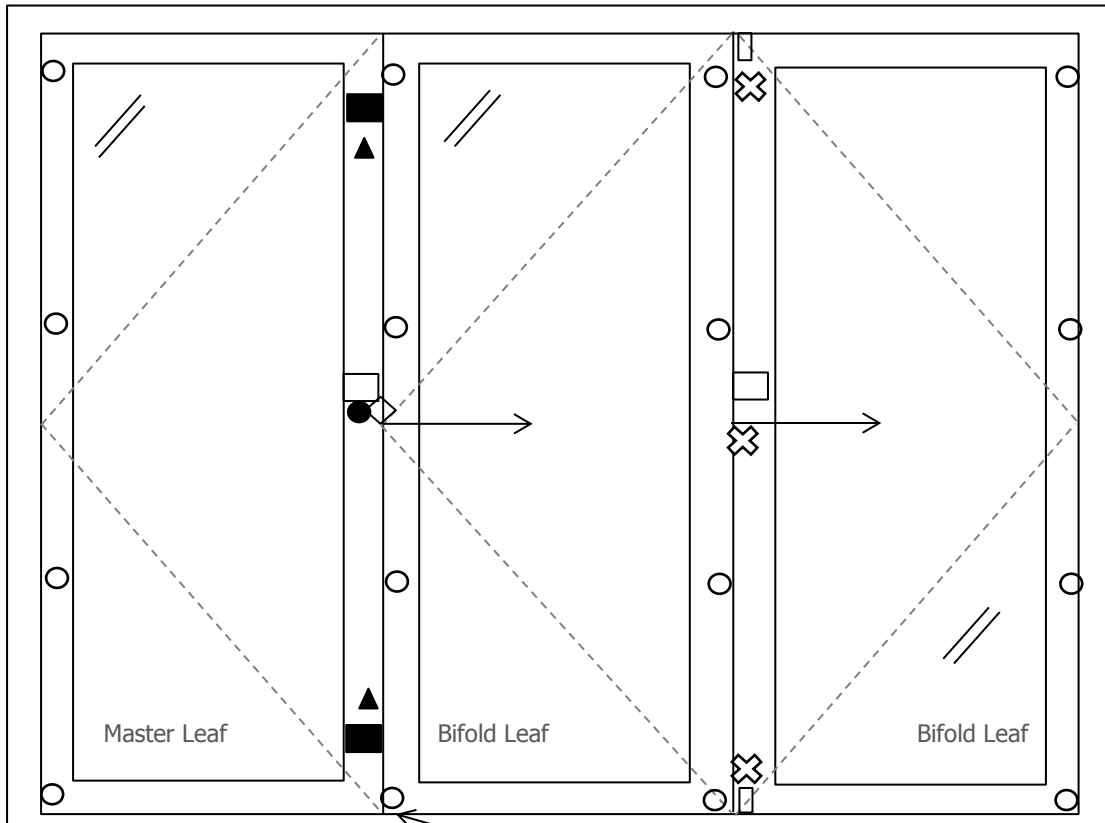

- - Handle
  - - Hinge
  - - Cylinder
  - - Cam
  - ▭ - Shoot Bolt
  - ◇ - Dead Bolt
  - ▲ - Hook Bolt
- Water Leakage Point
- Transducer Placement - ⊗

### Graph of Air Permeability Before Gusting.

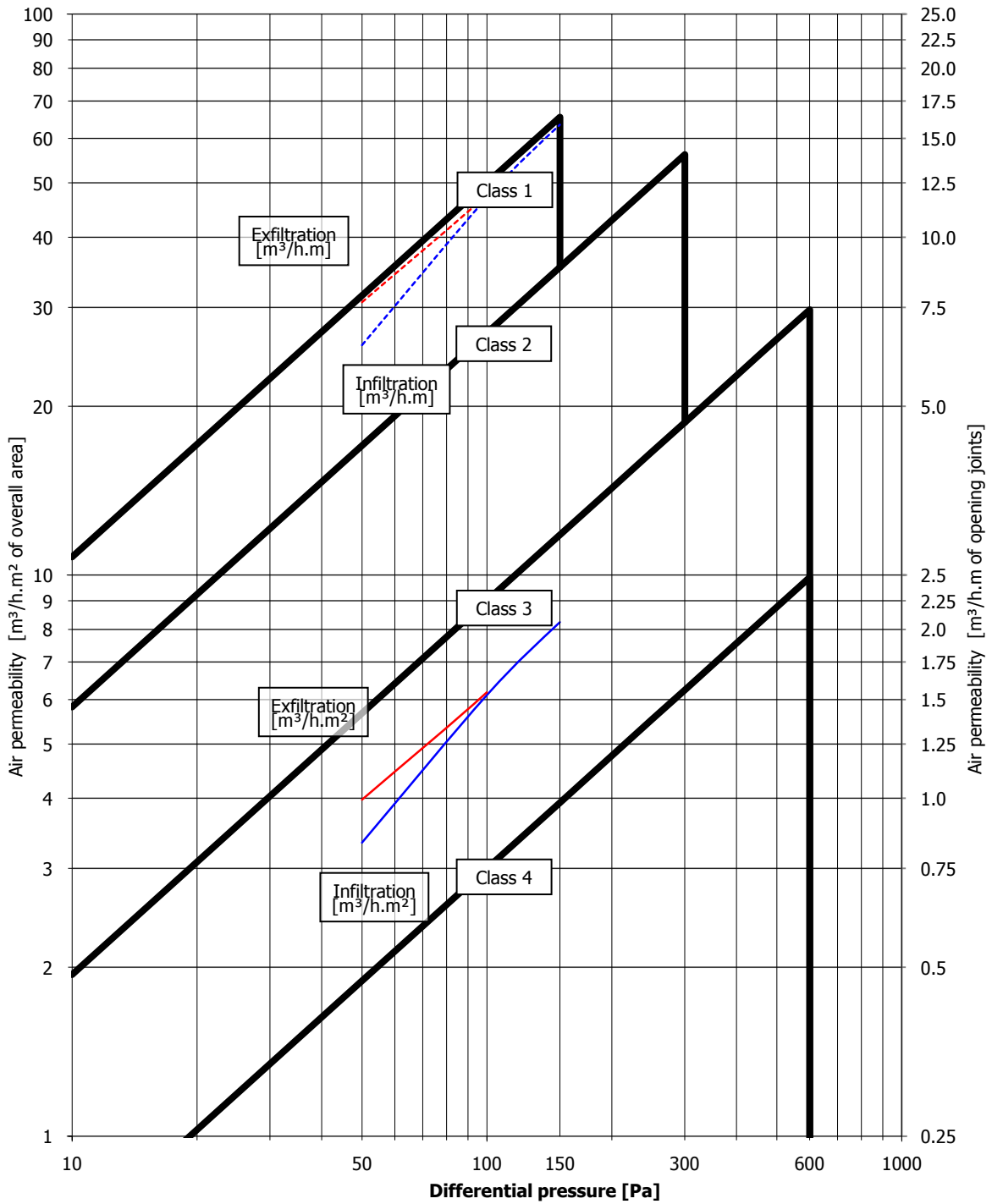

## Table of Average Air Permeability Before Gusting.

### AIR PERMEABILITY TEST RESULTS - BS 6375-1:2015 / BS EN 1026:2000

#### Clause 6.3 - Before resistance to wind tests

Three positive pressure pulses of 660Pa were applied prior to testing

Air Pressure [Pa]	Average rate of air leakage [m <sup>3</sup> /h]	Average rate of air leakage per meter length of opening joint [m <sup>3</sup> /h.m]	Average rate of air leakage relative to area of sample [m <sup>3</sup> /h.m <sup>2</sup> ]
50	35.1	7.04	3.66
100	59.1	11.83	6.14
150	79.7	15.98	8.30
200	-	-	-
250	-	-	-
300	-	-	-
450	-	-	-
600	-	-	-

Note: The figures in the table above give the leakage as an average of the leakage at positive pressure and the leakage at negative pressure

Total opening perimeter = 4.99m

Overall area = 9.61m<sup>2</sup>

BS 6375-1:2015 Clause 6.3 - Joint class = 1

BS 6375-1:2015 Clause 6.3 - Area class = 1

BS 6375-1:2015 Clause 6.3 - Overall class = 1

# Graph of Average Air Permeability Before Gusting.

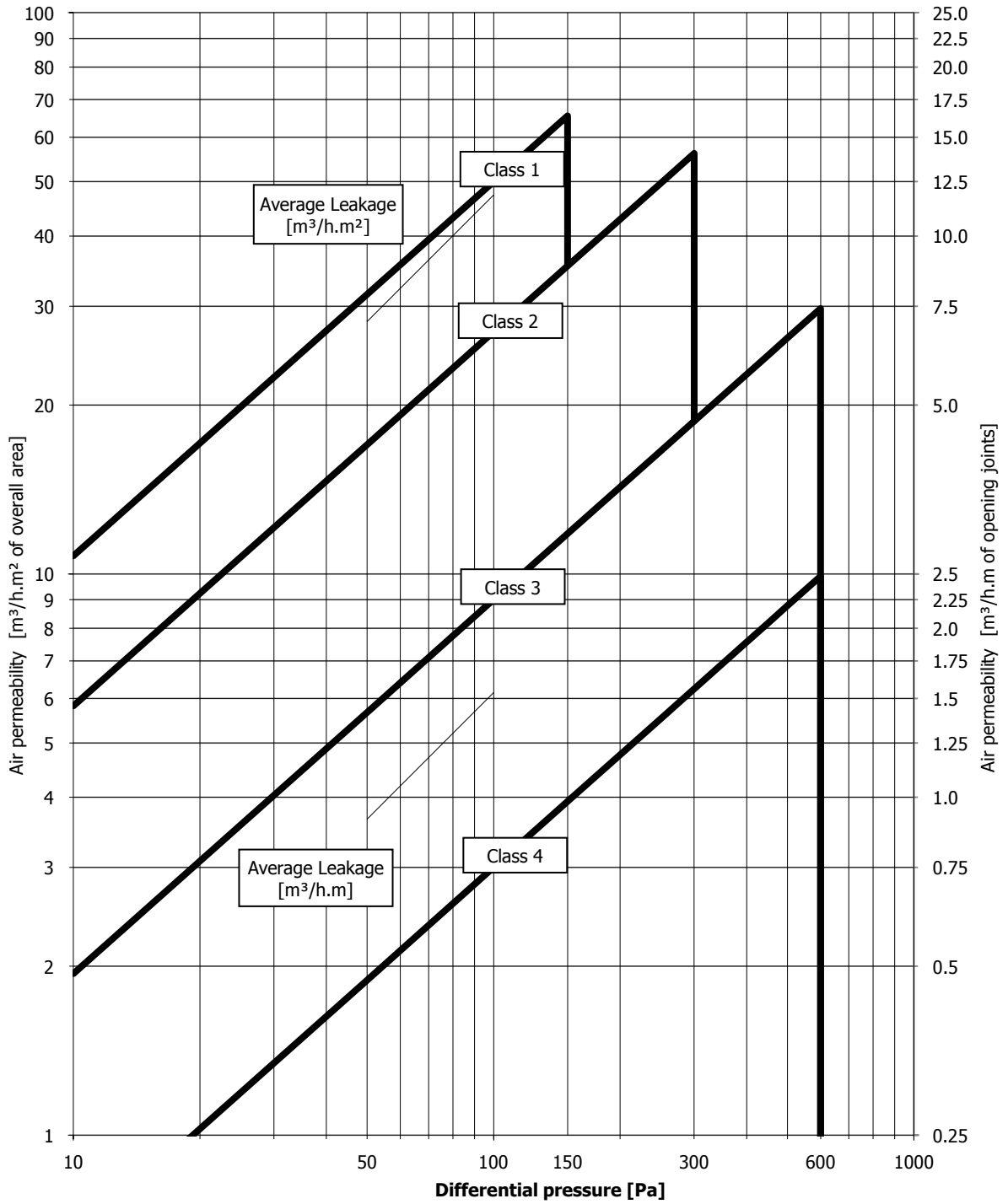

## Watertightness Test Results.

BS EN 1027:2000 Clause 7 Watertightness before resistance to wind loads

TABLE 2 - Spraying method 1A

Pressure (Pascals)	Point and time at which water leakage occurred
0	No leakage
50	No leakage
100	No Leakage
150	Water leaked from threshold opening joint onto sill at 2 minutes and 10 seconds
200	-
250	-
300	-
450	-
600	-
750	-
900	-
1050	-

### WIND LOAD RESISTANCE TEST RESULTS - BS EN 12211:2000

#### Clause 8 Resistance to wind load

##### P1 DEFLECTION TEST

Three positive pressure pulses at 880Pa were applied

No visible failures or functional defects to the test sample were observed after wind loads applied at a positive air pressure of 800Pa.

Actual deflection – 7.47mm (maximum deflection allowed 15.66mm)

Deflection/span ratio 1/314 (maximum ratio allowed 1/150)

Three negative pressure pulses at 880Pa were applied

No visible failures or functional defects to the test sample were observed after wind loads applied at a negative air pressure of 800Pa.

Actual deflection – 13.43mm (maximum deflection allowed 15.66mm)

Deflection/span ratio 1/174 (maximum ratio allowed 1/150)



**P2 REPEATED PRESSURE TEST**

No visible failures or functional defects to the test sample were observed after 50 cycles of repeated wind loads applied at a positive air pressure of 400Pa.

No visible failures or functional defects to the test sample were observed after 50 cycles of repeated wind loads applied at a negative air pressure of 400Pa.

In accordance with BS 6375-1:2015 Clause 6.5, as the classification after the resistance to wind load tests is the same as the classification before the resistance to wind load tests, the resulting classification for the sample is Class 1. (see following Table).

### Graph of Air Permeability After Gusting.

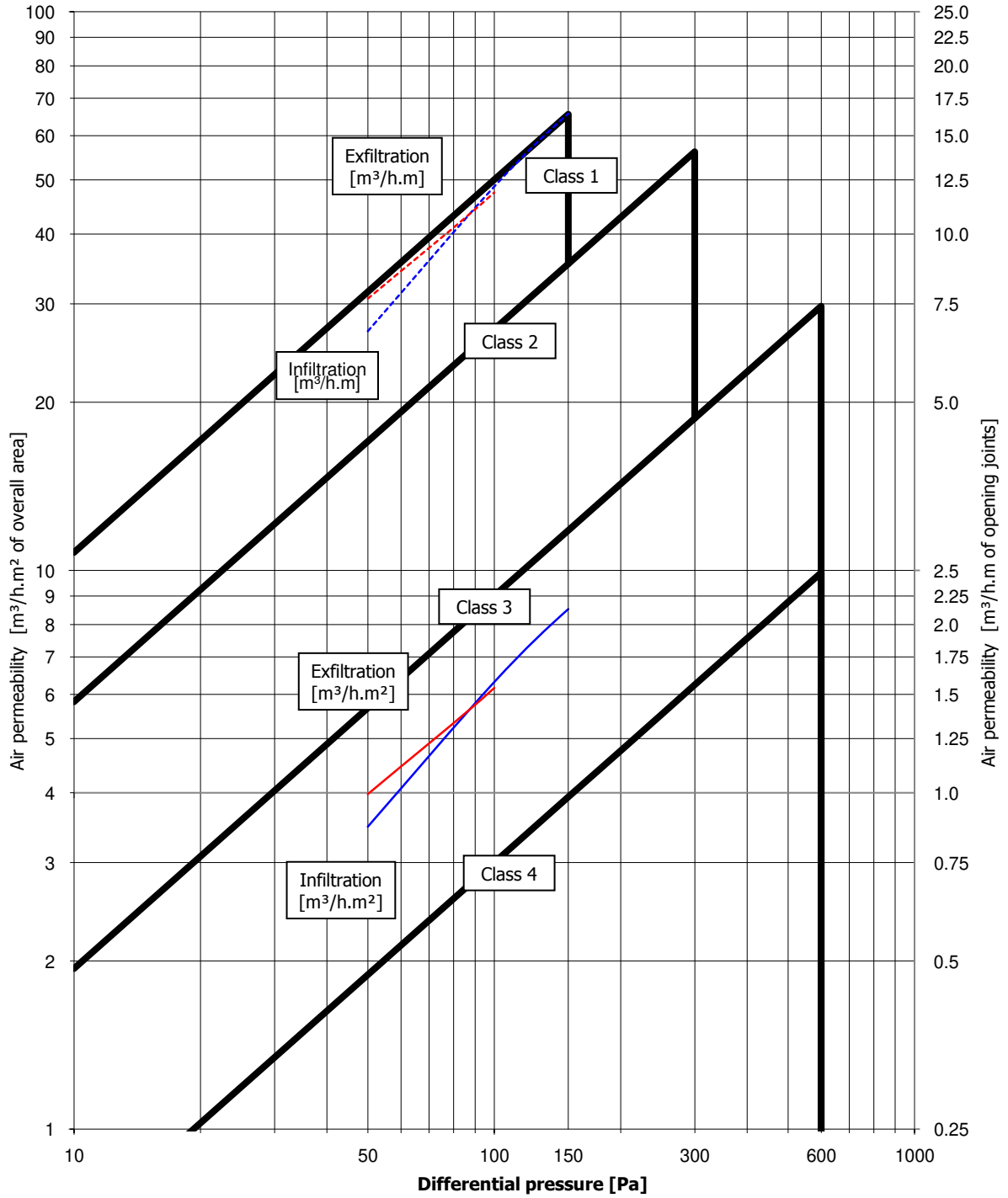

## Table of Average Air Permeability After Gusting.

### AIR PERMEABILITY TEST RESULTS - BS 6375-1:2015 / BS EN 1026:2000

#### Clause 6.5 - After resistance to wind tests

Three positive pressure pulses of 660Pa were applied prior to testing

Air Pressure [Pa]	Average rate of air leakage [m <sup>3</sup> /h]	Average rate of air leakage per meter length of opening joint [m <sup>3</sup> /h.m]	Average rate of air leakage relative to area of sample [m <sup>3</sup> /h.m <sup>2</sup> ]
50	35.8	7.18	3.73
100	59.9	12.01	6.24
150	81.3	16.29	8.46
200	-	-	-
250	-	-	-
300	-	-	-
450	-	-	-
600	-	-	-

Note: The figures in the table above give the leakage as an average of the leakage at positive pressure and the leakage at negative pressure

Total opening perimeter = 4.99m

Overall area = 9.61m<sup>2</sup>

BS 6375-1:2015 Clause 6.5 - Joint class = 1

BS 6375-1:2015 Clause 6.5 - Area class = 1

BS 6375-1:2015 Clause 6.5 - Overall class = 1

In accordance with BS 6375-1:2015 Clause 6.5, as the classification after the resistance to wind load tests is the same as the classification before the resistance to wind load tests, the resulting classification for the sample is Class 1.

### Graph of Average Air Permeability After Gusting.

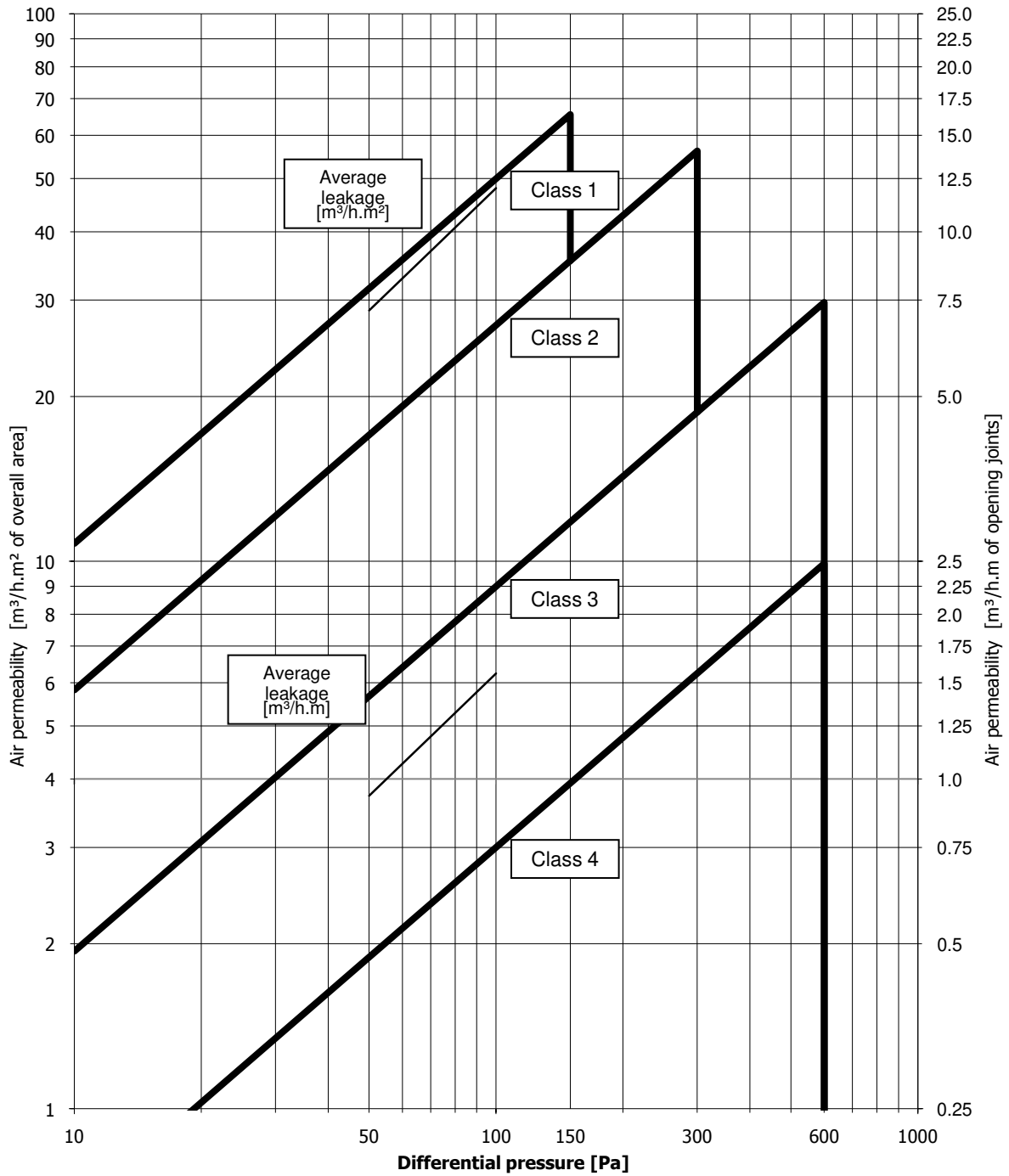

### Graph of Average Air Permeability After Gusting Including +20% Lines for Each Class.

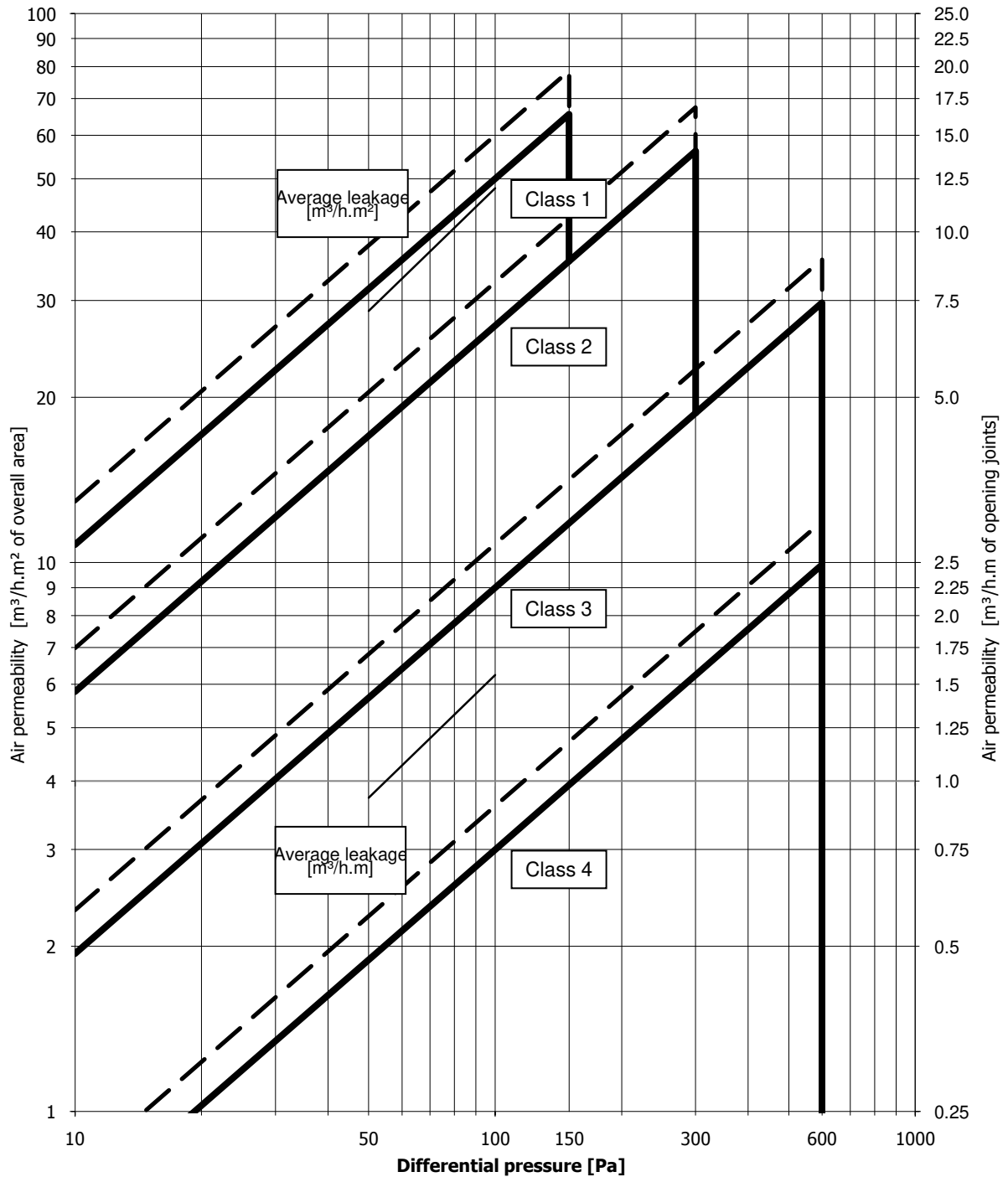

## Wind Load Resistance Test Results - BS EN 12211:2000.

### **P3 SAFETY TEST**

No parts of the test sample became detached and the test sample remained closed after a wind load safety test applied at a positive air pressure of 1200Pa.

No parts of the test sample became detached and the test sample remained closed after a wind load safety test applied at a negative air pressure of 1200Pa

**BS 6375-2:2009.**

**Clause 6**

**Performance characteristics and requirements for pedestrian doorsets**

**Assessment**

Clause 6.2 Operating Forces: EN12046-2 and EN12217

The sample was tested three times, closing the leaf, handle, locking the key, unlocking the key, handle opening and maintaining the leaf to stay open, and highest of the three results were then recorded.

Closing leaf force – 37.18N (maximum 75N)	Pass
Handle closing – 59.96N (maximum 100N)	Pass
Key torque to lock – 0.10Nm (maximum 20N)	Pass
Key torque to unlock – 0.10Nm (maximum 20N)	Pass
Handle opening – 60.93(maximum 100N)	Pass
Force to maintain opening – 42.73N (maximum 75N)	Pass

**Basic security (Annex A) .**

**BS 6375: Part 3: 2009 - Performance of Doors**

The objective of this test is to establish from if from the outside entry can be gained by defeating the glazing or locking system.

The force used did not result in permanent set or plastic deformation of any tool.

Damaged tools shall be replaced and the test did not exceed the maximum 3 minute time period.

The screwdriver was used to no effect

No entry could be effected	Pass
----------------------------	------

Description of Sample. (Sample 4)

<b>Sample type -</b>	A three leaf glaze in open out hinged bi-fold door assembly with one master leaf and two folding sliding leaves, full glass infill and standard threshold	
<b>Material -</b>	Aluminium	
<b>Finish -</b>	White	
<b>Fittings -</b>	<p><b>Master door</b> A five point locking (two hook bolts, two cams, 1 dead bolt) Fuhr espagnolette system, ACDV258 cylinder, key locking Mila Pro Secure handle and four pin hinges.</p> <p><b>Two Sliding leaves</b> A two point locking (two shoot bolts), twelve pin hinges and two rollers</p>	
<b>Weathersealing -</b>	Doubled sealed plastic weather strips	
<b>Glass -</b>	Double glazed with 4-20-4 mm toughened glass sealed units	
<b>Glass retention system -</b>	Internal beads and gaskets	
<b>Sample dimensions -</b>	Overall - Length: 3740mm	Height: 2570mm
	Master Leaves - Length: 1200mm	Height: 2500mm
	Slave Leaves - Length: 1200mm	Height: 2500mm
<b>Date of test -</b>	7 September 2016	
<b>Laboratory temperature -</b>	19.7°C	
<b>Laboratory humidity -</b>	35.4%	
<b>Laboratory Atmospheric Pressure -</b>	99.7kPa	



### Elevation Drawing of Door Assembly.

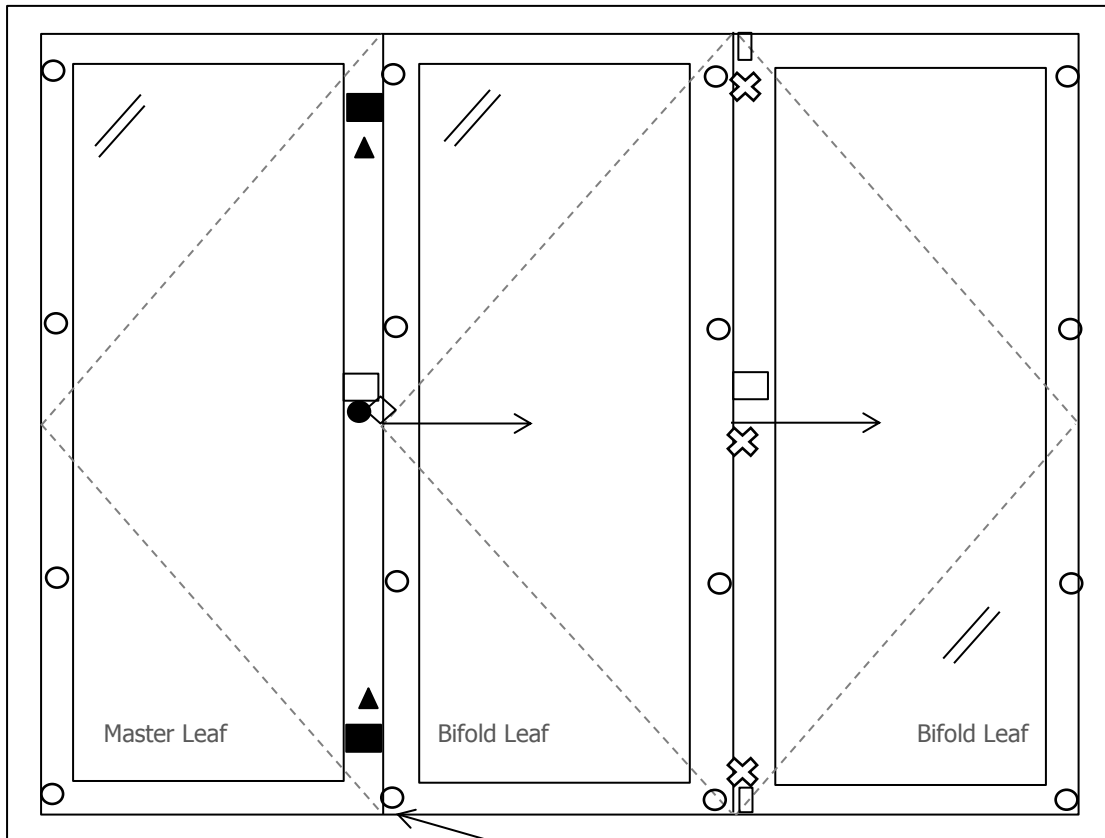

- - Handle
  - - Hinge
  - - Cylinder
  - - Cam
  - ◻ - Shoot Bolt
  - ◊ - Dead Bolt
  - ▲ - Hook Bolt
  - ⊗ - Transducer Placement
- Water Leakage Point

### Graph of Air Permeability Before Gusting.

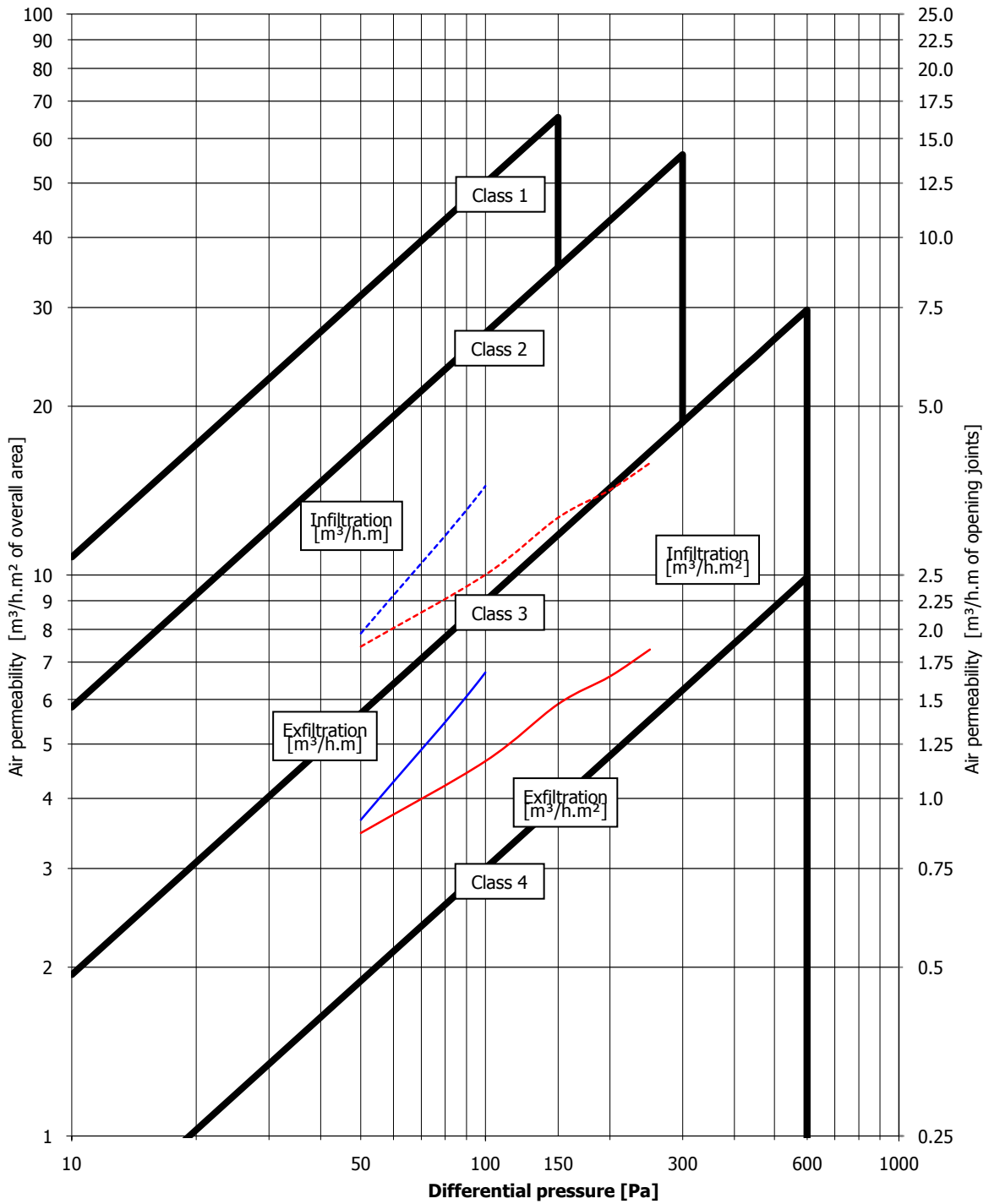

## Table of Average Air Permeability Before Gusting.

### AIR PERMEABILITY TEST RESULTS - BS 6375-1:2015 / BS EN 1026:2000

#### Clause 6.3 - Before resistance to wind tests

Three positive pressure pulses of 660Pa were applied prior to testing

Air Pressure [Pa]	Average rate of air leakage [m³/h]	Average rate of air leakage per meter length of opening joint [m³/h.m]	Average rate of air leakage relative to area of sample [m³/h.m²]
50	32.8	1.92	3.57
100	52.3	3.05	5.68
150	76.3	4.45	8.29
200	-	-	-
250	-	-	-
300	-	-	-
450	-	-	-
600	-	-	-

Note: The figures in the table above give the leakage as an average of the leakage at positive pressure and the leakage at negative pressure

Total opening perimeter = 17.12m

Overall area = 9.2m²

BS 6375-1:2015 Clause 6.3 - Joint class = 1

BS 6375-1:2015 Clause 6.3 - Area class = 1

BS 6375-1:2015 Clause 6.3 - Overall class = 1

### Graph of Average Air Permeability Before Gusting.

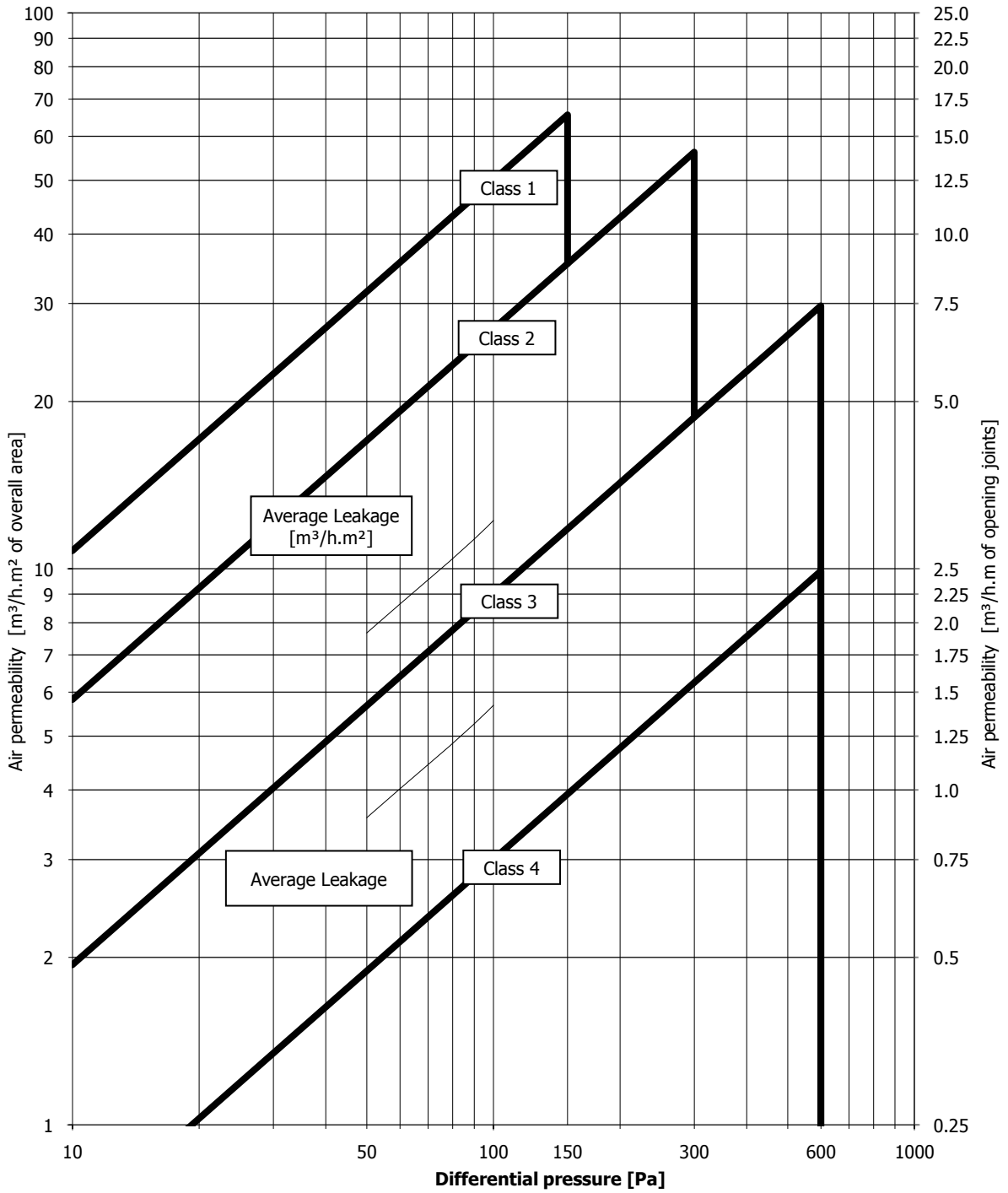

## Watertightness Test Results.

BS EN 1027:2000 Clause 7 Watertightness before resistance to wind loads

TABLE 2 - Spraying method 1A

Pressure (Pascals)	Point and time at which water leakage occurred
0	No leakage
50	No leakage
100	No Leakage
150	No Leakage
200	Water leaked from threshold opening joint onto sill at 58 seconds.
250	-
300	-
450	-
600	-
750	-
900	-
1050	-

### WIND LOAD RESISTANCE TEST RESULTS - BS EN 12211:2000

#### Clause 8 Resistance to wind load

##### P1 DEFLECTION TEST

Three positive pressure pulses at 880Pa were applied

No visible failures or functional defects to the test sample were observed after wind loads applied at a positive air pressure of 800Pa.

Actual deflection – 15.57mm (maximum deflection allowed 15.66mm)

Deflection/span ratio 1/150 (maximum ratio allowed 1/150)

Three negative pressure pulses at 880Pa were applied

No visible failures or functional defects to the test sample were observed after wind loads applied at a negative air pressure of 800Pa.

Actual deflection – 8.31mm (maximum deflection allowed 15.66mm)

Deflection/span ratio 1/282 (maximum ratio allowed 1/150)

**P2 REPEATED PRESSURE TEST**

No visible failures or functional defects to the test sample were observed after 50 cycles of repeated wind loads applied at a positive air pressure of 400Pa.

No visible failures or functional defects to the test sample were observed after 50 cycles of repeated wind loads applied at a negative air pressure of 400Pa.

In accordance with BS 6375-1:2015 Clause 6.5, as the classification after the resistance to wind load tests is the same as the classification before the resistance to wind load tests, the resulting classification for the sample is Class 1. (see following Table).

### Graph of Air Permeability After Gusting.

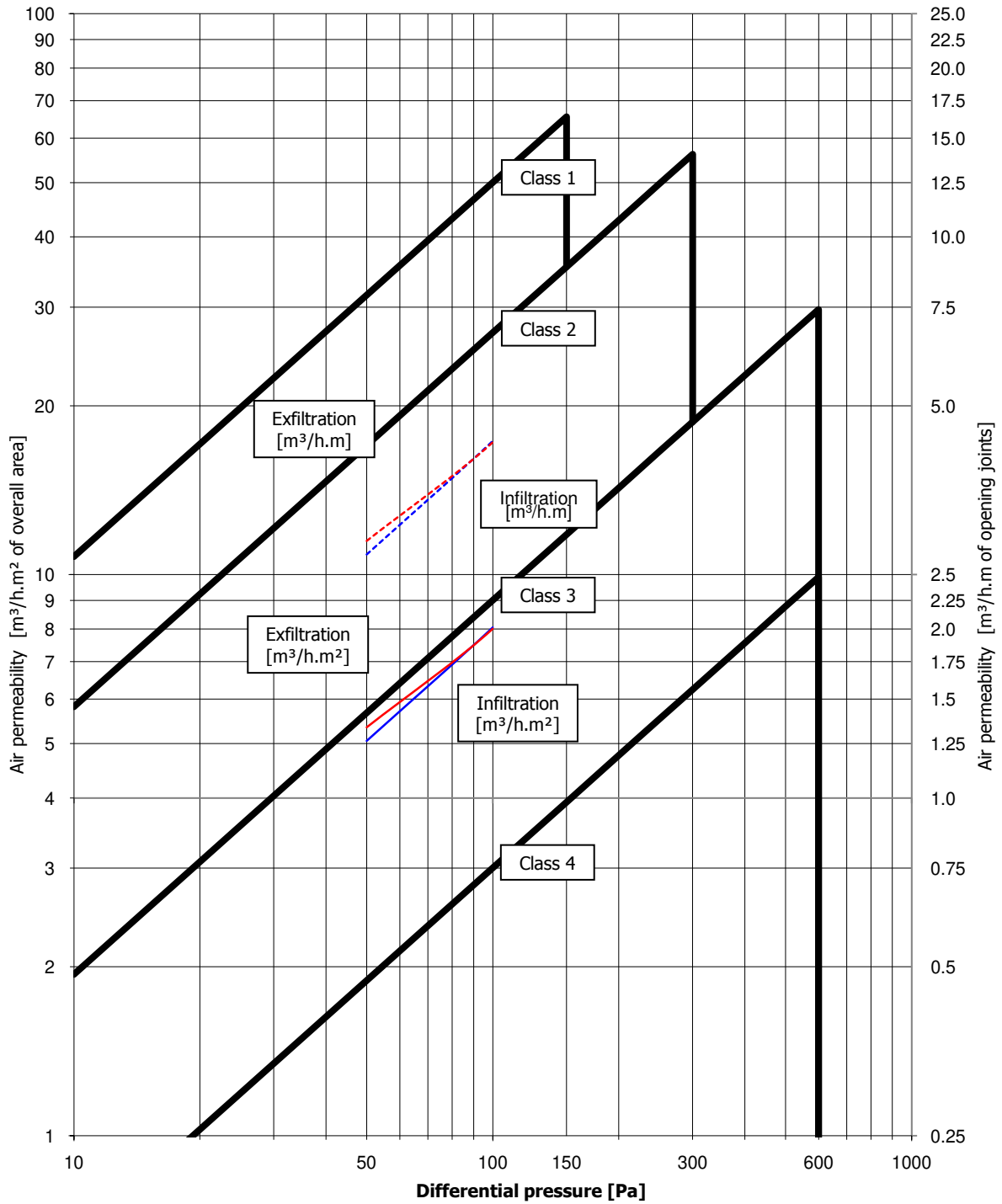

## Table of Average Air Permeability After Gusting.

### AIR PERMEABILITY TEST RESULTS - BS 6375-1:2015 / BS EN 1026:2000

#### Clause 6.5 - After resistance to wind tests

Three positive pressure pulses of 660Pa were applied prior to testing

Air Pressure [Pa]	Average rate of air leakage [m <sup>3</sup> /h]	Average rate of air leakage per meter length of opening joint [m <sup>3</sup> /h.m]	Average rate of air leakage relative to area of sample [m <sup>3</sup> /h.m <sup>2</sup> ]
50	47.8	2.79	5.20
100	73.9	4.32	8.03
150	102.6	5.99	11.15
200	-	-	-
250	-	-	-
300	-	-	-
450	-	-	-
600	-	-	-

Note: The figures in the table above give the leakage as an average of the leakage at positive pressure and the leakage at negative pressure

Total opening perimeter = 17.12m

Overall area = 9.2m<sup>2</sup>

BS 6375-1:2015 Clause 6.5 - Joint class = 1

BS 6375-1:2015 Clause 6.5 - Area class = 1

BS 6375-1:2015 Clause 6.5 - Overall class = 1

In accordance with BS 6375-1:2015 Clause 6.5, as the classification after the resistance to wind load tests is the same as the classification before the resistance to wind load tests, the resulting classification for the sample is Class 1.



# Graph of Average Air Permeability After Gusting.

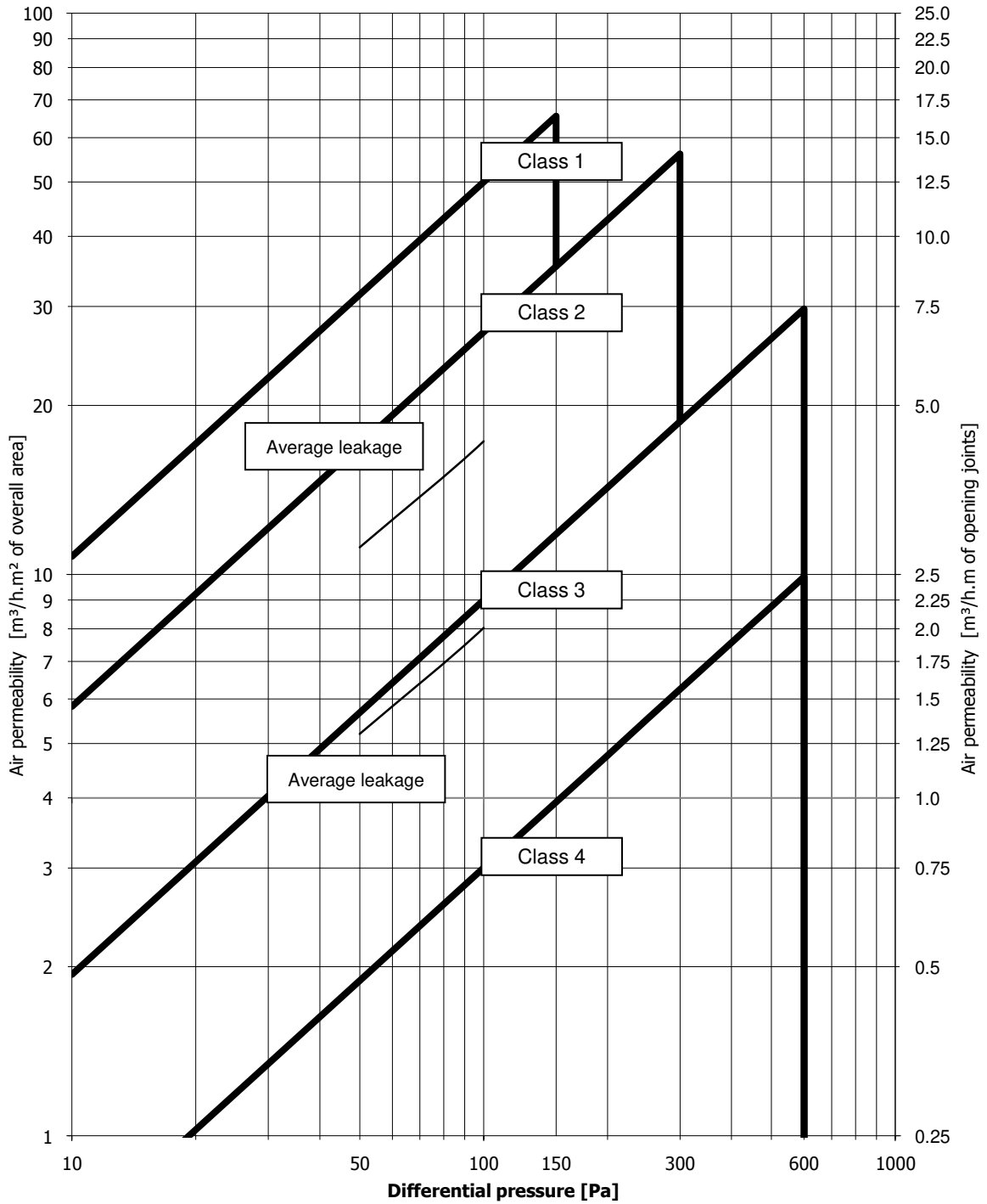

### Graph of Average Air Permeability After Gusting Including +20% Lines for Each Class.

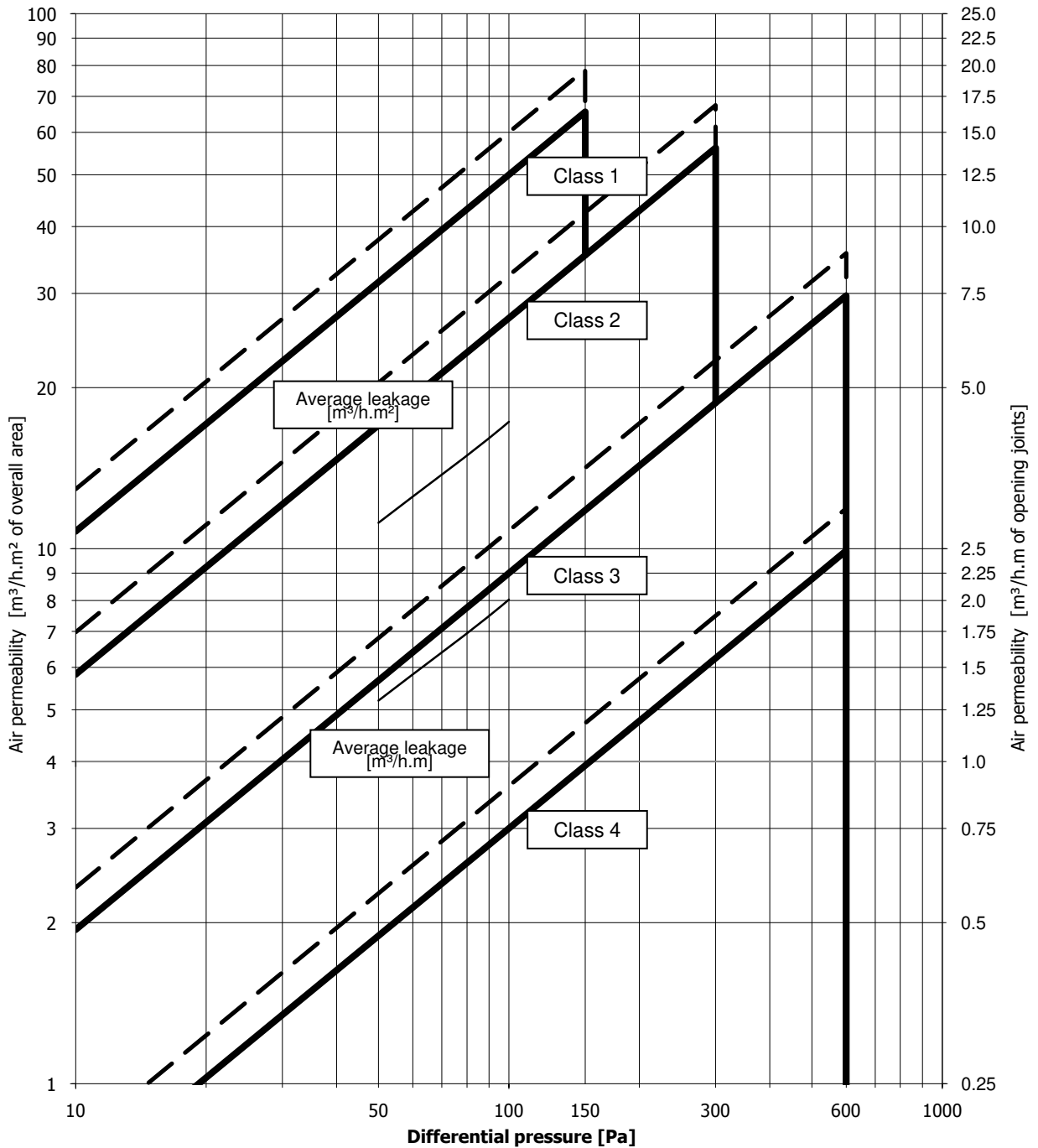

## Wind Load Resistance Test Results - BS EN 12211:2000.

### **P3 SAFETY TEST**

No parts of the test sample became detached and the test sample remained closed after a wind load safety test applied at a positive air pressure of 1200Pa.

No parts of the test sample became detached and the test sample remained closed after a wind load safety test applied at a negative air pressure of 1200Pa

**BS 6375-2:2009.**

**Clause 6**

**Performance characteristics and requirements for pedestrian doorsets**

**Assessment**

Clause 6.2 Operating Forces: EN12046-2 and EN12217

The sample was tested three times, closing the leaf, handle, locking the key, unlocking the key, handle opening and maintaining the leaf to stay open, and highest of the three results were then recorded.

Closing leaf force – 35.77N (maximum 75N)	Pass
Handle closing – 61.12N (maximum 100N)	Pass
Key torque to lock – 0.10Nm (maximum 20Nm)	Pass
Key torque to unlock – 0.10Nm (maximum 20N)	Pass
Handle opening – 64.08 (maximum 100N)	Pass
Force to maintain opening – 42.42N (maximum 75N)	Pass

**Basic security (Annex A) .**

**BS 6375: Part 3: 2009 - Performance of Doors**

The objective of this test is to establish from if from the outside entry can be gained by defeating the glazing or locking system.

The force used did not result in permanent set or plastic deformation of any tool.

Damaged tools shall be replaced and the test did not exceed the maximum 3 minute time period.

The screwdriver was used to no effect

No entry could be effected	Pass
----------------------------	------

## Description of Sample. (Sample 5)

<b>Sample type -</b>	A three leaf glaze in open in hinged bi-fold door assembly with one master leaf and two folding sliding leaves, full glass infill and standard threshold	
<b>Material -</b>	Aluminium	
<b>Finish -</b>	White	
<b>Fittings -</b>	<p><b>Master door</b> A five point locking (two hook bolts, two cams, 1 dead bolt) Fuhr espagnolette system, ACDV258 cylinder, key locking Mila Pro Secure handle and four pin hinges.</p> <p><b>Two Sliding leaves</b> A two point locking (two shoot bolts), twelve pin hinges and two rollers</p>	
<b>Weathersealing -</b>	Doubled sealed plastic weather strips	
<b>Glass -</b>	Double glazed with 4-20-4 mm toughened glass sealed units	
<b>Glass retention system -</b>	Internal beads and gaskets	
<b>Sample dimensions -</b>	Overall - Length: 3740mm Master Leaves - Length: 1200mm Slave Leaves - Length: 1200mm	Height: 2570mm Height: 2500mm Height: 2500mm
<b>Date of test -</b>	7 September 2016	
<b>Laboratory temperature -</b>	20.0°C	
<b>Laboratory humidity -</b>	34.8%	
<b>Laboratory Atmospheric Pressure -</b>	99.8kPa	

### Elevation Drawing of Door Assembly.

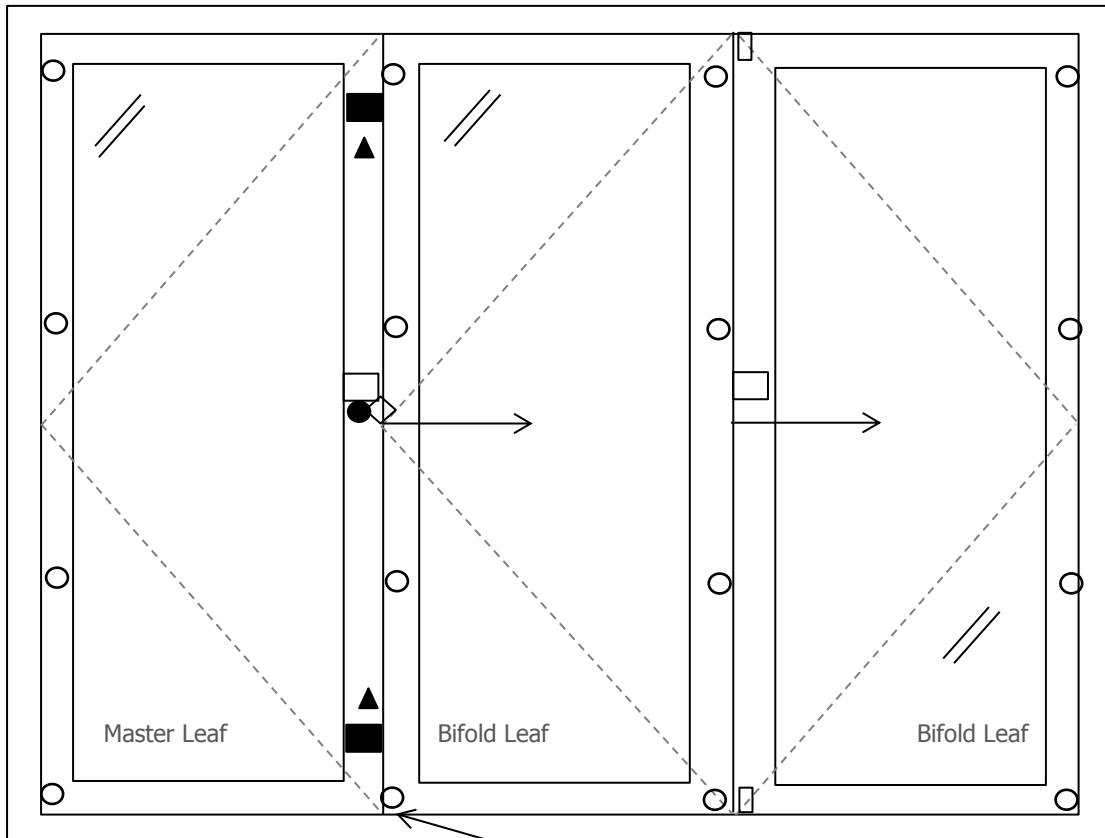

- - Handle
  - - Hinge
  - - Cylinder
  - - Cam
  - ▭ - Shoot Bolt
  - ◇ - Dead Bolt
  - ▲ - Hook Bolt
- Water Leakage Point

# Graph of Air Permeability.

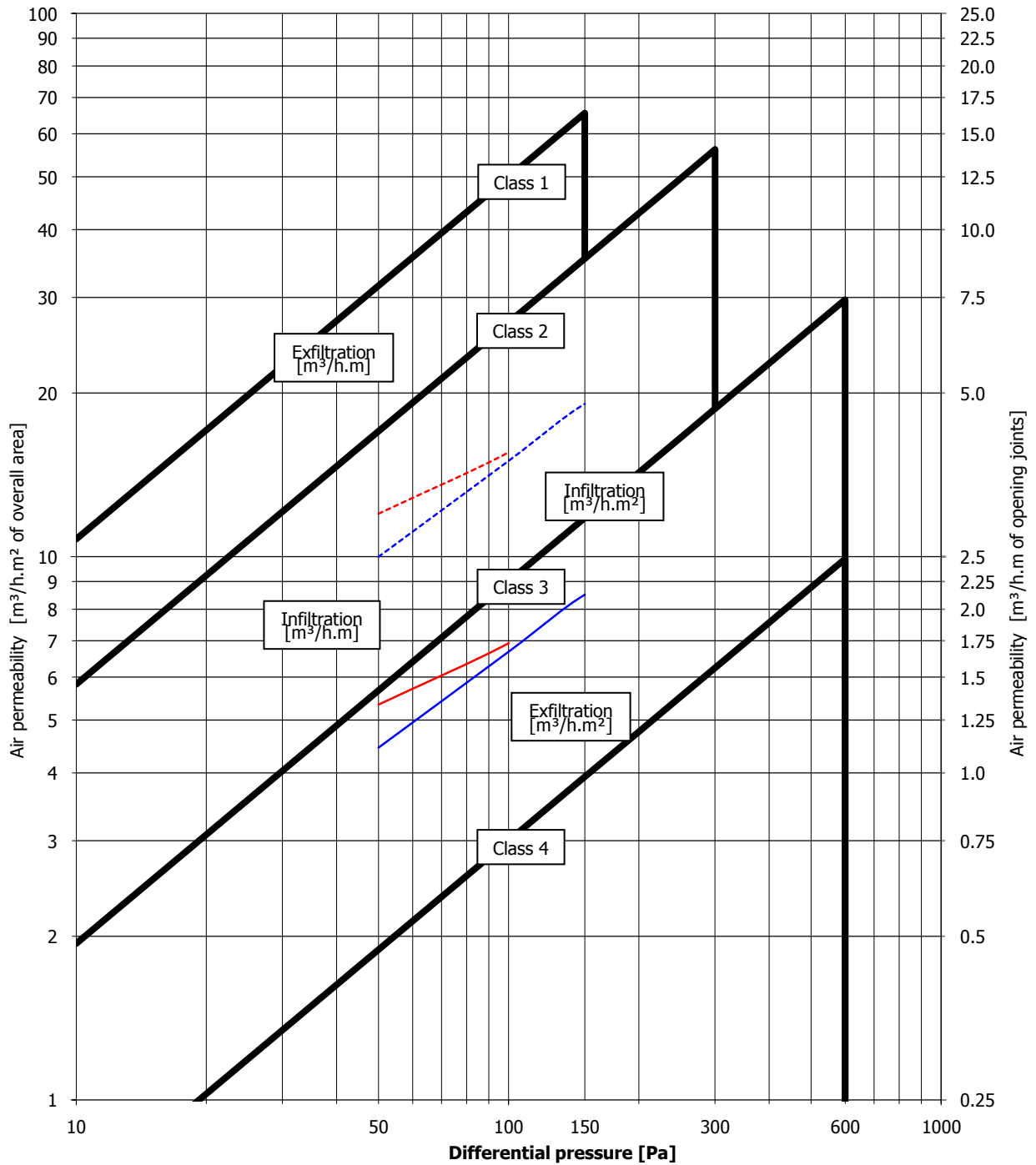

## Table of Average Air Permeability.

### AIR PERMEABILITY TEST RESULTS - BS 6375-1:2015 / BS EN 1026:2000

#### Clause 6.3 - Before resistance to wind tests

Three positive pressure pulses of 660Pa were applied prior to testing

Air Pressure [Pa]	Average rate of air leakage [m³/h]	Average rate of air leakage per meter length of opening joint [m³/h.m]	Average rate of air leakage relative to area of sample [m³/h.m²]
50	47.0	2.75	4.89
100	65.4	3.82	6.81
150	81.9	4.79	8.52
200	-	-	-
250	-	-	-
300	-	-	-
450	-	-	-
600	-	-	-

Note: The figures in the table above give the leakage as an average of the leakage at positive pressure and the leakage at negative pressure

Total opening perimeter = 17.12m

Overall area = 9.6118m²

BS 6375-1:2015 Clause 6.3 - Joint class = 1

BS 6375-1:2015 Clause 6.3 - Area class = 1

BS 6375-1:2015 Clause 6.3 - Overall class = 1



# Graph of Average Air Permeability.

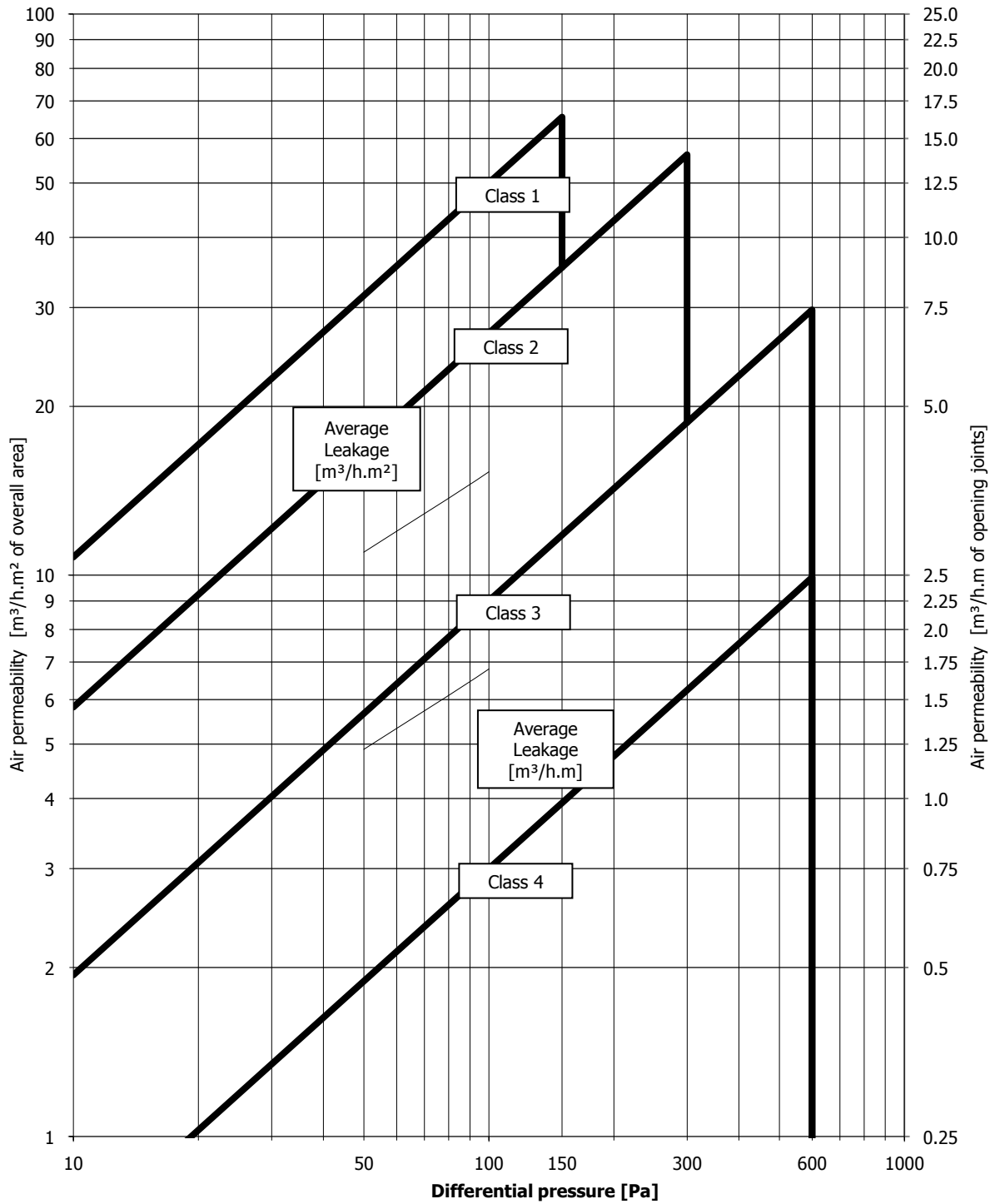

ftfgjfj

## Watertightness Test Results.

BS EN 1027:2000 Clause 7 Watertightness before resistance to wind loads

TABLE 2 - Spraying method 1A

Pressure (Pascals)	Point and time at which water leakage occurred
0	No leakage
50	No leakage
100	No Leakage
150	No Leakage
200	No Leakage
250	No Leakage
300	No Leakage
450	No Leakage
600	Water leaked from threshold opening joint onto sill at 0 minutes and 10 seconds.
750	-
900	-
1050	-

## BS 6375-2:2009.

### Clause 6

#### Performance characteristics and requirements for pedestrian doorsets

#### Assessment

Clause 6.2 Operating Forces: EN12046-2 and EN12217

The sample was tested three times, closing the leaf, handle, locking the key, unlocking the key, handle opening and maintaining the leaf to stay open, and highest of the three results were then recorded.

Closing leaf force – 41.22N (maximum 75N)	Pass
Handle closing – 59.03N (maximum 100N)	Pass
Key torque to lock – 0.10Nm (maximum 20Nm)	Pass
Key torque to unlock – 0.10Nm (maximum 20Nm)	Pass
Handle opening – 63.13N (maximum 100N)	Pass
Force to maintain opening – 46.88N (maximum 75N)	Pass

## Basic security (Annex A) . BS 6375: Part 3: 2009 - Performance of Doors

The objective of this test is to establish from if from the outside entry can be gained by defeating the glazing or locking system.

The force used did not result in permanent set or plastic deformation of any tool.

Damaged tools shall be replaced and the test did not exceed the maximum 3 minute time period.

The screwdriver was used to no effect

No entry could be effected

Pass

Photograph of Sample.



## Test Samples.

Sample Id	ER Number	Description
1	10156882	Aluminium Bi-Fold Doors

## Test Requirements.

PAS 24/BS4873 Type Test

Clause	Requirements
<b>Results table</b>	Actual test results <i>See Table A - PAS 24/BS4873 Type Test</i>

## Summary of Test Results (Table A).

Sample Id	Description	Air Permeability	Watertightness	Wind Resistance
1	Open out standard (PAS24) Pass			
2	Open Out Low Threshold	Class 1	2A	A2 (Pass at 800Pa)
3	Open In Low Threshold	Class 1	3A	A2 (Pass at 800Pa)
4	Open Out Standard Threshold	Class 1	4A	A2 (Pass at 800Pa)
5	Open In Standard Threshold	Class 1	8A	Not Assessed

## Description of Test Samples.

Sample Description
1 off three leaf glaze in open out hinged bi-fold door assembly with one master leaf and two folding sliding leaves, full glass infill and low threshold (Sample 2)
1 off three leaf glaze in open in hinged bi-fold door assembly with one master leaf and two folding sliding leaves, full glass infill and low threshold (Sample 3)
2 off three leaf glaze in open out hinged bi-fold door assemblies with one master leaf and two folding sliding leaves, full glass infill and standard threshold (Samples 1 and 4)
1 off three leaf glaze in open in hinged bi-fold door assembly with one master leaf and two folding sliding leaves, full glass infill and standard threshold (Sample 5)

## Glossary of Terms.

PASS: Complies. Tested by BSI engineers at BSI laboratories.

PASS1: Complies. Witnessed by BSI engineers in manufacturers laboratory.

PASS2: Complies. Tests carried out by third party lab; results accepted by BSI.

PASS\*: Report resulted in uncertainty and states that Compliance is more probable than non-compliance.

FAIL: Non compliance – Product does not meet the requirements of this clause.

FAIL\*: Report resulted in uncertainty and states that Non-compliance is more probable than compliance.

N/A: Not applicable to design under consideration.

N/T: Not tested due to similarity to previously tested item; reference earlier test report.

## Conditions of Issue.

This Test Report is issued subject to the conditions stated in current issue of 'BSI Terms of Service'. The results contained herein apply only to the particular sample(s) tested and to the specific tests carried out, as detailed in this Test Report. The issuing of this Test Report does not indicate any measure of Approval, Certification, Supervision, Control or Surveillance by BSI of any product. No extract, abridgement or abstraction from a Test Report may be published or used to advertise a product without the written consent of BSI, who reserve the absolute right to agree or reject all or any of the details of any items or publicity for which consent may be sought.

Should you wish to speak with BSI in relation to this report, please contact Customer Services on +44 (0)8450 80 9000.

BSI  
Kitemark House  
Maylands Avenue  
Hemel Hempstead  
Hertfordshire  
HP2 4SQ



Opinions and Interpretations expressed herein are outside the scope of our UKAS accreditation.

Unless otherwise stated, any results not obtained from testing in a BSI laboratory are outside the scope of our UKAS accreditation

\*\*\* End of Report \*\*\*